

# Dell PowerEdge R660xs

## Technical Guide

## Notes, cautions, and warnings

 **NOTE:** A NOTE indicates important information that helps you make better use of your product.

 **CAUTION:** A CAUTION indicates either potential damage to hardware or loss of data and tells you how to avoid the problem.

 **WARNING:** A WARNING indicates a potential for property damage, personal injury, or death.

<b>Chapter 1: System overview.....</b>	<b>6</b>
Key workloads.....	6
New technologies.....	6
<b>Chapter 2: System features and generational comparison.....</b>	<b>8</b>
<b>Chapter 3: Chassis views and features.....</b>	<b>10</b>
Chassis views.....	10
Front view of the system.....	10
Rear view of the system.....	14
Inside the system .....	16
System diagnostics and indicator codes.....	16
<b>Chapter 4: Processor.....</b>	<b>19</b>
Processor features .....	19
Supported processors.....	19
Chipset.....	20
Chipset features.....	20
<b>Chapter 5: Memory subsystem.....</b>	<b>21</b>
Supported memory.....	21
General memory module installation guidelines.....	22
<b>Chapter 6: Storage.....</b>	<b>23</b>
Storage controllers.....	23
Storage controller feature matrix.....	23
Server storage controllers User Guide.....	25
RAID - Redundant Array of Independent Disks.....	25
Datasheets and PERC performance scaling decks.....	25
Boot Optimized Storage Solution (BOSS).....	25
Supported Drives.....	27
External Storage.....	27
<b>Chapter 7: Networking.....</b>	<b>28</b>
Overview.....	28
OCP 3.0 support.....	28
Supported OCP cards.....	28
OCP NIC 3.0 vs. rack Network Daughter Card comparisons.....	29
<b>Chapter 8: Slot priority matrix.....</b>	<b>30</b>
Expansion card installation guidelines.....	30
<b>Chapter 9: Power, thermal, and acoustics.....</b>	<b>39</b>

Power.....	39
PSU specifications.....	40
Thermal.....	42
Acoustics.....	42
Acoustical configurations .....	42
<b>Chapter 10: Rack, rails, and cable management.....</b>	<b>44</b>
Rails information.....	44
A11 Sliding Rails features summary.....	44
A8 Static Rails features summary.....	45
Cable Management Arm.....	46
Strain Relief Bar .....	46
Rack Installation.....	47
<b>Chapter 11: Supported operating systems.....</b>	<b>52</b>
<b>Chapter 12: Dell Systems Management.....</b>	<b>53</b>
Integrated Dell Remote Access Controller (iDRAC).....	53
Systems Management software support matrix.....	54
<b>Chapter 13: Appendix A. Standards compliance.....</b>	<b>55</b>
<b>Chapter 14: Appendix B: Additional specifications.....</b>	<b>56</b>
Chassis dimensions .....	56
System weight.....	57
Video specifications.....	57
USB ports specifications.....	58
PSU rating.....	58
Environmental specifications.....	59
Thermal restrictions.....	60
<b>Chapter 15: Appendix C Additional resources.....</b>	<b>71</b>
Documentation.....	72
Customer kits.....	72
Dell Upgrades.....	72
Upgrades portfolio.....	72
Upgrades reference links.....	74
<b>Chapter 16: Appendix D: Service and support.....</b>	<b>75</b>
Default support levels.....	75
Default deployment levels.....	75
Other services and support information.....	75
Dell deployment services.....	75
Dell custom deployment Services.....	79
Dell Residency Services.....	79
Dell Data Migration Services.....	79
Dell Enterprise Support Services.....	80
Enterprise connectivity.....	82
Dell TechDirect.....	83



Dell Technologies Consulting Services.....83

# System overview

The Dell PowerEdge R660xs is Dell's latest 2-socket, 1U rack server designed to run the most popular workloads using highly scalable memory, I/O, and network options. The systems feature the 4th and 5th Generation Intel® Xeon Scalable Processor (Socket E1/LGA4677-1), up to 16 DIMMs, PCI Express® (PCIe) 5.0 enabled expansion slots, and a broad selection of network interface technologies.

## Topics:

- [Key workloads](#)
- [New technologies](#)

## Key workloads

The target workloads for the PowerEdge R660xs include Virtualization, Public/Private Cloud, Scale-Out Database, and High-Performance compute.

## New technologies

**Table 1. New technologies**

Technology	Detailed Description
Up to 2 x 5th Gen Intel(R) Xeon(R) Scalable Processors (Emerald Rapids)	Core count: Up to 28 per processor Up to 3.9 GHz UPI speed: Up to 3x UPIs/Socket at 12.8 GT/s or 14.4 or 16 GT/s or 20 GT/s Maximum number of PCIe lanes: Integrated 80 PCIe 5.0 lanes @ 32 GT/s PCIe Gen5 Maximum TDP: 250 W
Up to 2 x 4th Gen Intel(R) Xeon(R) Scalable Processors (Sapphire Rapids)	Core count: Up to 32 per processor UPI speed: Up to 3x UPIs/Socket at 12.8 GT/s or 14.4 or 16 GT/s Maximum number of PCIe lanes: Integrated 80 PCIe 5.0 lanes @ 32 GT/s PCIe Gen5 Maximum TDP: 250 W
DDR5 ECC memory up to 5200 MT/s	Maximum 8 DIMMs per processor and 16 DIMMs in total 1 DIMMs per channel (1 DPC) Supports DDR5 registered DIMMs (RDIMMs)
Flex I/O	LOM: 2 x 1 GbE with BCM5720 LAN controller Rear IO with 1 GbE Dedicated Management Network Port, USB 3.0 x1, USB 2.0 x1 and VGA port OCP Mezz 3.0 (supported by x8 PCIe lanes) Serial port option

**Table 1. New technologies (continued)**

<b>Technology</b>	<b>Detailed Description</b>
CPLD 1-wire	Support payload data of front PERC, Riser, BOSS-N1, BP, and Rear I/O to BIOS and iDRAC.
Dedicated PERC	Front storage module PERC with front PERC 11/12 and PERC 12.2
Software RAID	OS RAID / S160
Power Supplies	60 mm dimension is the new PSU form factor on 16G design <ul style="list-style-type: none"><li>● 600 W Platinum 100–240 VAC/ 240 VDC</li><li>● 700 W Titanium 200–240 VAC/240 VDC</li><li>● 800 W Platinum 100–240 VAC/ 240 VDC</li><li>● 1100 W DC/-48–(-60) V</li><li>● 1100 W Titanium 100–240 VAC/ 240 VDC</li><li>● 1400 W Titanium 100–240 VAC/ 240 VDC</li><li>● 1400 W Platinum 100–240 VAC/ 240 VDC</li><li>● 1400 W Titanium 277 VAC / 366 VDC</li><li>● 1800 W Titanium 200–240 VAC/ 240 VDC</li></ul>

## System features and generational comparison

The following table shows the comparison between the PowerEdge R660xs with the PowerEdge R650xs.

**Table 2. Feature comparison**

Feature	PowerEdge R660xs	PowerEdge R650xs
Processor	<ul style="list-style-type: none"> <li>Up to 2 x 4th Gen Intel(R) Xeon(R) Scalable Processors (Sapphire Rapids) with up to 32 cores</li> <li>Up to 2 x 5th Gen Intel(R) Xeon(R) Scalable Processors (Emerald Rapids) with up to 28 cores</li> </ul>	Maximum two 3 <sup>rd</sup> Generation Intel® Xeon Scalable Processor
Processor Interconnect	Intel Ultra Path Interconnect (UPI) , up to 3 links per CPU	Intel Ultra Path Interconnect (UPI)
Memory	16 DDR5 DIMM slots Supports RDIMM 1.5 TB max Speed maximum 5200 MT/s for 5th generation and 4800 MT/s for 4th generation processors Supports registered ECC DDR5 DIMMs only NVDIMM : No	16 x RDIMM DDR4 with ECC, Up to 3200 MT/s
Storage Drives	Front bays: <ul style="list-style-type: none"> <li>0 drive bay</li> <li>Up to 4 x 3.5-inch SAS/SATA (HDD/SSD) max 96 TB</li> <li>Up to 8 x 2.5-inch SAS/SATA/NVMe (HDD/SSD) max 122.88 TB</li> <li>Up to 10 x 2.5-inch SAS/SATA/NVMe (HDD/SSD) max 153.6 TB</li> </ul> Rear bays: <ul style="list-style-type: none"> <li>Up to 2x 2.5-inch SAS/SATA/NVMe (HDD/SSD) max 15.2 TB</li> </ul>	Front bays: <ul style="list-style-type: none"> <li>0 drive bay</li> <li>Up to 4x 3.5-inch SAS/SATA (HDD/SSD) max 64 TB</li> <li>Up to 8x 2.5-inch SAS/SATA/NVMe (HDD/SSD) max 61.44 TB</li> <li>Up to 10x 2.5-inch SAS/SATA/NVMe (HDD/SSD) max 76.8 TB</li> </ul> Rear bays: <ul style="list-style-type: none"> <li>Up to 2x 2.5-inch SAS/SATA/NVMe (HDD/SSD) max 15.36 TB</li> </ul>
Storage Controllers	Internal controllers: PERC H355, PERC H755, PERC H755N, HBA465i PERC H965i, HBA355i, HBA465i (post-RTS) Internal Boot: Boot Optimized Storage Subsystem (BOSS-N1): HWRAID 2 x M.2 SSDs and Internal USB External PERC (RAID): HBA355e, H965e Software RAID: S160	Internal controllers: PERC H345, PERC H355, PERC H745, PERC H755, PERC H755N, HBA355i, S150 Internal Boot: Internal Dual SD Module, Boot Optimized Storage Subsystem (BOSS S1): HWRAID 2 x M.2 SSDs, USB External PERC (RAID): PERC H840, HBA355e
PCIe Slots	Up to 2 x PCIe Gen5 or Up to 3 x PCIe Gen4	Up to 3 x PCIe Gen4
Embedded NIC (LOM)	2 x 1 GbE	2 x 1 GbE
Networking options (OCP 3.0)	Max 1 OCP 3.0 (x8 PCIE lanes)	Max 1 OCP 3.0 (x16 PCIE lanes)

**Table 2. Feature comparison (continued)**

Feature	PowerEdge R660xs	PowerEdge R650xs
I/O Ports	Front ports: <ul style="list-style-type: none"> <li>● 1 x iDRAC Direct (Micro-AB USB) port</li> <li>● 1 x USB 2.0</li> <li>● 1 x VGA</li> </ul> Rear ports: <ul style="list-style-type: none"> <li>● 1 x Dedicated iDRAC Ethernet port</li> <li>● 1 x USB 2.0</li> <li>● 1 x USB 3.0</li> <li>● 1 x Serial (optional)</li> <li>● 1 x VGA</li> <li>● 2 x Ethernet</li> </ul> Internal port <ul style="list-style-type: none"> <li>● 1 x USB 3.0 (optional)</li> </ul>	Front ports: <ul style="list-style-type: none"> <li>● 1 x iDRAC Direct (Micro-AB USB) port</li> <li>● 1 x USB 2.0</li> <li>● 1 x VGA</li> </ul> Rear ports: <ul style="list-style-type: none"> <li>● 1 x Dedicated iDRAC Ethernet port</li> <li>● 1 x USB 2.0</li> <li>● 1 x USB 3.0</li> <li>● 1 x Serial (optional)</li> <li>● 1 x VGA</li> <li>● 2 x Ethernet</li> </ul> Internal port <ul style="list-style-type: none"> <li>● 1 x USB 3.0 (optional)</li> </ul>
Rack Height	1U	1U
Power Supplies	<ul style="list-style-type: none"> <li>● 600 W Platinum 100-240 VAC/ 240 VDC</li> <li>● 700 W Titanium 200-240 VAC/240 VDC</li> <li>● 800 W Platinum 100-240 VAC/ 240 VDC</li> <li>● 1100 W DC/-48-(-60) V</li> <li>● 1100 W Titanium 100-240 VAC/ 240 VDC</li> <li>● 1400 W Titanium 100-240 VAC/ 240 VDC</li> <li>● 1400 W Platinum 100-240 VAC/ 240 VDC</li> <li>● 1400 W Titanium 277 VAC/ 366 VDC</li> <li>● 1800 W Titanium 200-240 VAC/240 VDC</li> </ul>	<ul style="list-style-type: none"> <li>● 600 W Platinum 100-240 VAC/ 240 VDC</li> <li>● 700 W Titanium 200-240 VAC/240 VDC</li> <li>● 800 W Platinum 100-240 VAC/ 240 VDC</li> <li>● 1100 W DC/-48-(-60) V</li> <li>● 1100 W Titanium 100-240 VAC/ 240 VDC</li> <li>● 1400 W Platinum 100-240 VAC/ 240 VDC</li> <li>● 1800 W Titanium 200-240 VAC/240 VDC</li> </ul>
System Management	<ul style="list-style-type: none"> <li>● iDRAC9</li> <li>● iDRAC Direct</li> <li>● iDRAC RESTful API with Redfish</li> <li>● iDRAC Service Module</li> <li>● Open Server Manager</li> <li>● Quick Sync 2 wireless module</li> </ul>	<ul style="list-style-type: none"> <li>● iDRAC9</li> <li>● iDRAC Direct</li> <li>● iDRAC Service Module</li> <li>● Quick Sync 2 wireless module</li> </ul>
Availability	Hot-plug drives Hot-plug redundant cooling Hot-plug redundant power supplies	Hot-plug drives Hot-plug redundant cooling Hot-plug redundant power supplies IDSDM

# Chassis views and features

## Topics:

- Chassis views

## Chassis views

### Front view of the system

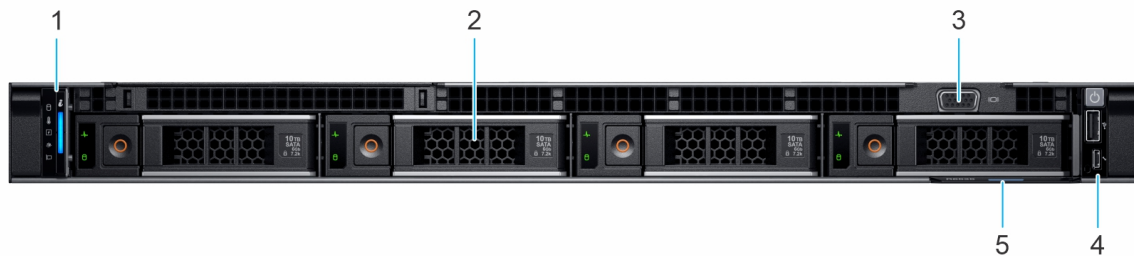



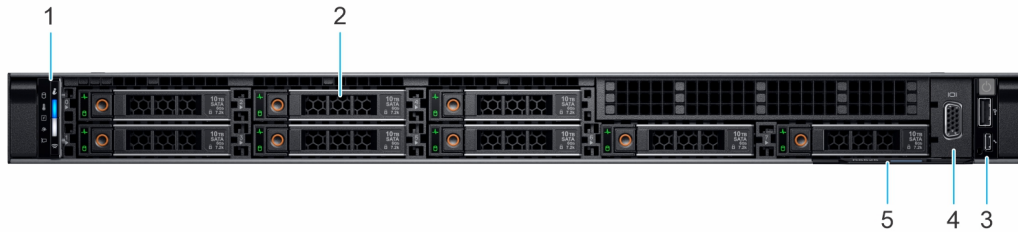
Figure 1. Front view of 4 x 3.5-inch drive system

Table 3. Features available on the front of the system

Item	Ports, panels, and slots	Icon	Description
1	Left control panel	N/A	<p>Contains the system health, system ID, status LED, and the iDRAC Quick Sync 2 (wireless) indicator.</p> <p><b>NOTE:</b> The iDRAC Quick Sync 2 indicator is available only on certain configurations.</p> <ul style="list-style-type: none"> <li>• Status LED: Enables you to identify any failed hardware components. There are up to five status LEDs and an overall system health LED (Chassis health and system ID) bar. For more information, see the Status LED indicators section.</li> <li>• Quick Sync 2 (wireless): Indicates a Quick Sync enabled system. The Quick Sync feature is optional. This feature allows management of the system by using mobile devices called as OpenManage Mobile (OMM) feature. Using iDRAC Quick Sync 2 with OpenManage Mobile (OMM) aggregates hardware or firmware inventory and various system level diagnostic and error information that can be used in troubleshooting the system. For more information, see the <a href="#">Integrated Dell Remote Access Controller User's Guide</a></li> </ul>
2	Drive	N/A	Enables you to install drives that are supported on your system.
3	VGA port		Enables you to connect a display device to the system.
4	Right control panel	N/A	Contains the power button, USB port, iDRAC Direct micro port, and the iDRAC Direct status LED.
5	Express service tag	N/A	The Express Service Tag is a slide-out label panel that contains system information such as Service Tag, NIC, MAC address, and

**Table 3. Features available on the front of the system (continued)**

Item	Ports, panels, and slots	Icon	Description
			so on. If you have opted for the secure default access to iDRAC, the Information tag will also contain the iDRAC secure default password.



**Figure 2. Front view of 8 x 2.5-inch drive system**

**Table 4. Features available on the front of the system**



Item	Ports, panels, and slots	Icon	Description
1	Left control panel	N/A	Contains the system health, system ID, status LED, and the iDRAC Quick Sync 2 (wireless) indicator. <b>i NOTE:</b> The iDRAC Quick Sync 2 indicator is available only on certain configurations. <ul style="list-style-type: none"> <li>• Status LED: Enables you to identify any failed hardware components. There are up to five status LEDs and an overall system health LED (Chassis health and system ID) bar. For more information, see the Status LED indicators section.</li> <li>• Quick Sync 2 (wireless): Indicates a Quick Sync enabled system. The Quick Sync feature is optional. This feature allows management of the system by using mobile devices called as OpenManage Mobile (OMM) feature. Using iDRAC Quick Sync 2 with OpenManage Mobile (OMM) aggregates hardware or firmware inventory and various system level diagnostic and error information that can be used in troubleshooting the system. For more information, see the <a href="#">Integrated Dell Remote Access Controller User's Guide</a></li> </ul>
2	Drive	N/A	Enables you to install drives that are supported on your system.
3	Right control panel	N/A	Contains the power button, USB port, iDRAC Direct micro port, and the iDRAC Direct status LED.
4	VGA port		Enables you to connect a display device to the system.
5	Express service tag	N/A	The Express Service Tag is a slide-out label panel that contains system information such as Service Tag, NIC, MAC address, and so on. If you have opted for the secure default access to iDRAC, the Information tag will also contain the iDRAC secure default password.



Figure 3. Front view of 10 x 2.5-inch drive system

Table 5. Features available on the front of the system

Item	Ports, panels, and slots	Icon	Description
1	Left control panel	N/A	<p>Contains the system health, system ID, status LED, and the iDRAC Quick Sync 2 (wireless) indicator.</p> <p><b>NOTE:</b> The iDRAC Quick Sync 2 indicator is available only on certain configurations.</p> <ul style="list-style-type: none"> <li>Status LED: Enables you to identify any failed hardware components. There are up to five status LEDs and an overall system health LED (Chassis health and system ID) bar. For more information, see the Status LED indicators section.</li> <li>Quick Sync 2 (wireless): Indicates a Quick Sync enabled system. The Quick Sync feature is optional. This feature allows management of the system by using mobile devices called as OpenManage Mobile (OMM) feature. Using iDRAC Quick Sync 2 with OpenManage Mobile (OMM) aggregates hardware or firmware inventory and various system level diagnostic and error information that can be used in troubleshooting the system. For more information, see the <a href="#">Integrated Dell Remote Access Controller User's Guide</a></li> </ul>
2	Drive	N/A	Enables you to install drives that are supported on your system. For more information about drives, see the Drives section.
3	Right control panel	N/A	Contains the power button, USB port, iDRAC Direct micro port, and the iDRAC Direct status LED.
4	VGA port		Enables you to connect a display device to the system. For more information, see the VGA port specifications section.
5	Express service tag	N/A	The Express Service Tag is a slide-out label panel that contains system information such as Service Tag, NIC, MAC address, and so on. If you have opted for the secure default access to iDRAC, the Information tag will also contain the iDRAC secure default password.

### Left control panel view

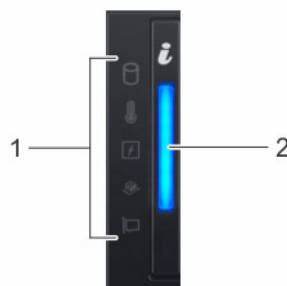

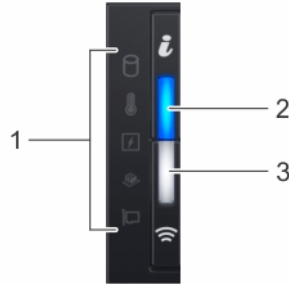


Figure 4. Left control panel





**Table 6. Left control panel**


Item	Indicator, button, or connector	Icon	Description
1	Status LED indicators	NA	Indicates the status of the system. For more information, see the <a href="#">Status LED indicators</a> section.
2	System health and system ID indicator		Indicates the status of the system. For more information, see the <a href="#">System health and system ID indicator codes</a> section.



**Figure 5. Left control panel with optional iDRAC Quick Sync 2 indicator**

**Table 7. Left control panel with optional iDRAC Quick Sync 2 indicator**

Item	Indicator, button, or connector	Icon	Description
1	Status LED indicators	N/A	Indicates the status of the system. For more information, see the <a href="#">Status LED indicators</a> section.
2	System health and system ID indicator		Indicates the status of the system. For more information, see the <a href="#">System health and system ID indicator codes</a> section.
3	iDRAC Quick Sync 2 wireless indicator (optional)		Indicates if the iDRAC Quick Sync 2 wireless option is activated. The Quick Sync 2 feature allows management of the system using mobile devices. This feature aggregates hardware/firmware inventory and various system level diagnostic/error information that can be used in troubleshooting the system. You can access system inventory, Dell Lifecycle Controller logs or system logs, system health status, and also configure iDRAC, BIOS, and networking parameters. You can also launch the virtual Keyboard, Video, and Mouse (KVM) viewer and virtual Kernel-based Virtual Machine (KVM), on a supported mobile device. For more information, see the Integrated Dell Remote Access Controller User's Guide at <a href="#">PowerEdge manuals</a> .

 **NOTE:** For more information about the indicator codes, see the [System diagnostics and indicator codes](#) section.

## Right control panel view

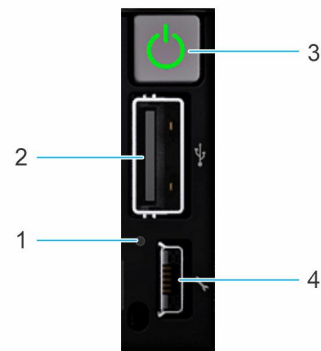





Figure 6. Right control panel

Table 8. Right control panel

Item	Indicator or button	Icon	Description
1	iDRAC Direct LED indicator	N/A	The iDRAC Direct LED indicator lights up to indicate that the iDRAC Direct port is actively connected to a device.
2	USB 2.0-compliant port		The USB port is a 4-pin connector and 2.0-compliant. This port enables you to connect USB devices to the system.
3	Power button		Indicates if the system is powered on or off. Press the power button to manually power on or off the system.  <b>NOTE:</b> Press the power button to gracefully shut down an ACPI-compliant operating system.
4	iDRAC Direct port (Micro-AB USB)		The iDRAC Direct port (Micro-AB USB) enables you to access the iDRAC direct Micro-AB USB features. For more information, see the <a href="#">iDRAC Manuals</a> .  <b>NOTE:</b> You can configure iDRAC Direct by using a USB to micro USB (type AB) cable, which you can connect to your laptop or tablet. Cable length should not exceed 3 feet (0.91 meters). Performance could be affected by cable quality.

## Rear view of the system

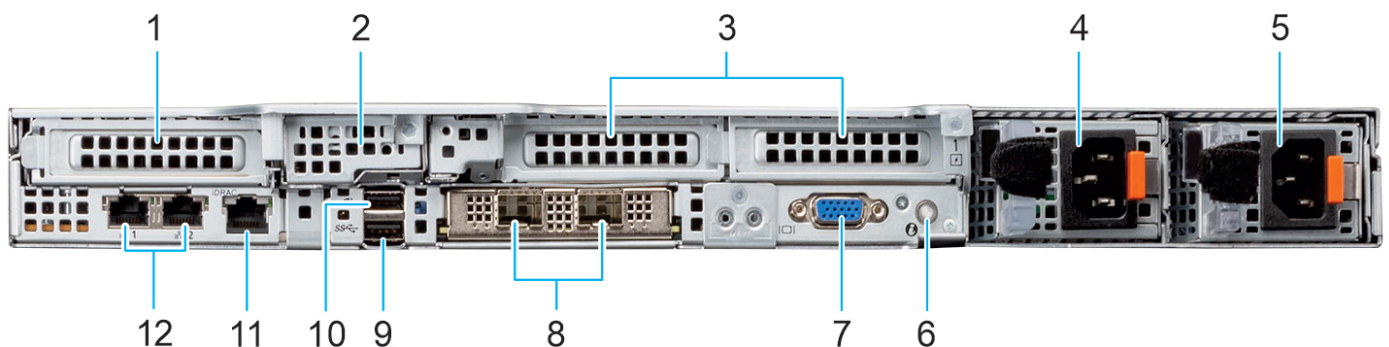








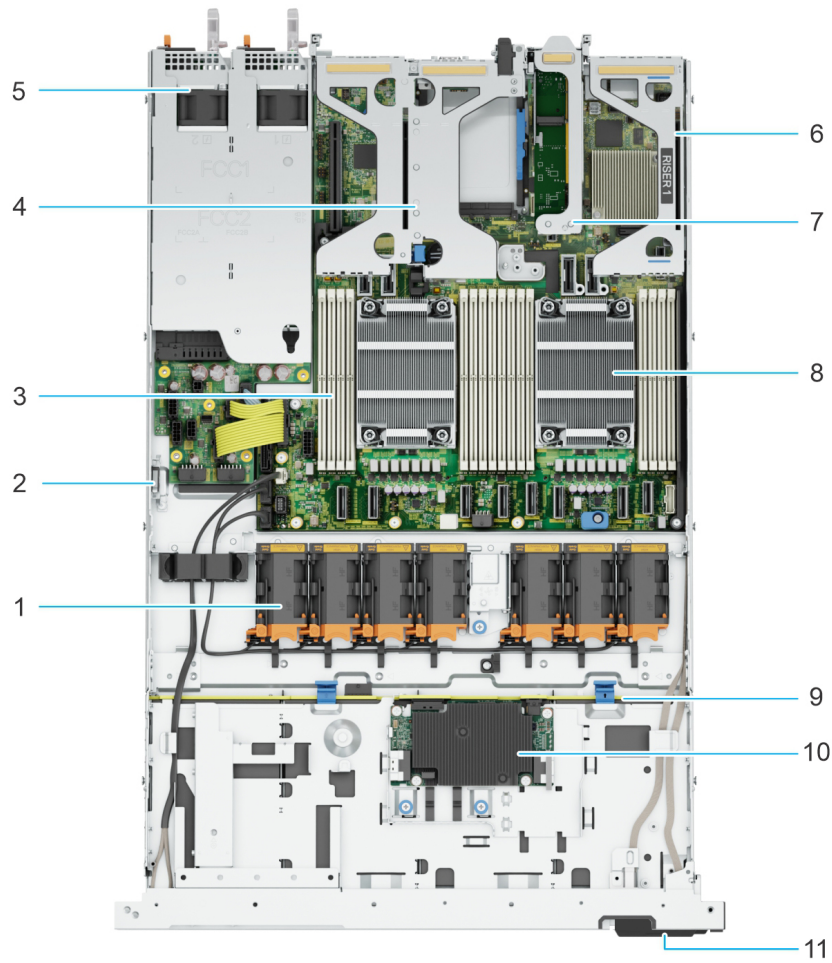


Figure 7. Rear view of the system

**Table 9. Rear view of the system**

Item	Ports, panels, or slots	Icon	Description
1	PCIe expansion card riser 1 (slot 1)	N/A	Enables you to connect PCI Express expansion cards.
2	BOSS riser	N/A	Enables you to connect BOSS card.
3	PCIe expansion card riser 2 (slot 2 and slot 3) or Rear drive module	N/A	Enables you to connect PCI Express expansion cards. Or Enables you to install rear drives that are supported on your system.
4	Power supply unit (PSU 1)		PSU1 is the primary PSU of the system.
5	Power supply unit (PSU 2)		PSU2 is the secondary PSU of the system.
6	System identification button		<p>Press the system ID button:</p> <ul style="list-style-type: none"> <li>To locate a particular system within a rack.</li> <li>To turn the system ID on or off.</li> </ul> <p>To reset iDRAC, press and hold the button for 16 seconds.</p> <p><b>NOTE:</b></p> <ul style="list-style-type: none"> <li>To reset iDRAC using system ID, ensure that the system ID button is enabled in the iDRAC setup.</li> <li>If the system stops responding during POST, press and hold the system ID button (for more than five seconds) to enter the BIOS progress mode.</li> </ul>
7	VGA port		Enables you to connect a display device to the system.
8	OCP NIC port	N/A	This port supports OCP 3.0.
9	USB 3.0 port		This port is USB 3.0-compliant.
10	USB 2.0 port		This port is USB 2.0-compliant.
11	iDRAC dedicated port		Enables you to remotely access iDRAC. For more information, see the iDRAC User's Guide at <a href="#">PowerEdge manuals</a> .
12	NIC ports		The NIC ports that are integrated on the system board provide network connectivity. These NIC ports can also be shared with iDRAC when iDRAC network settings is set to shared mode.

## Inside the system



**Figure 8. Inside the system**

- |                         |                     |
|-------------------------|---------------------|
| 1. Fan                  | 2. Intrusion switch |
| 3. Memory module slots  | 4. Riser 2          |
| 5. PSU 1 and PSU 2      | 6. Riser 1          |
| 7. BOSS riser           | 8. Heat sink        |
| 9. Drive backplane      | 10. Front PERC      |
| 11. Express service tag |                     |

## System diagnostics and indicator codes

The diagnostic indicators on the system front panel display system status during system startup.






### Status LED indicators

**NOTE:** The indicators display solid amber if any error occurs.



Figure 9. Status LED indicators

Table 10. Status LED indicators and descriptions

Icon	Description	Condition	Corrective action
	Drive indicator	The indicator turns solid amber if there is a drive error.	<ul style="list-style-type: none"> <li>• Check the System Event Log to determine if the drive has an error.</li> <li>• Run the appropriate Online Diagnostics test. Restart the system and run embedded diagnostics (ePSA).</li> <li>• If the drives are configured in a RAID array, restart the system, and enter the host adapter configuration utility program.</li> </ul>
	Temperature indicator	The indicator turns solid amber if the system experiences a thermal error (for example, the ambient temperature is out of range or there is a fan failure).	<p>Ensure that none of the following conditions exist:</p> <ul style="list-style-type: none"> <li>• A cooling fan has been removed or has failed.</li> <li>• System cover, air shrouds, or back filler bracket has been removed.</li> <li>• Ambient temperature is too high.</li> <li>• External airflow is obstructed.</li> </ul> <p>If the problem persists, see the <a href="#">Getting help</a> section.</p>
	Electrical indicator	The indicator turns solid amber if the system experiences an electrical error (for example, voltage out of range, or a failed power supply unit (PSU) or voltage regulator).	<p>Check the System Event Log or system messages for the specific issue. If it is due to a problem with the PSU, check the LED on the PSU. Reseat the PSU.</p> <p>If the problem persists, see the <a href="#">Getting help</a> section.</p>
	Memory indicator	The indicator turns solid amber if a memory error occurs.	<p>Check the System Event Log or system messages for the location of the failed memory. Reseat the memory module.</p> <p>If the problem persists, see the <a href="#">Getting help</a> section.</p>
	PCIe indicator	The indicator turns solid amber if a PCIe card experiences an error.	<p>Restart the system. Update any required drivers for the PCIe card. Reinstall the card.</p> <p>If the problem persists, see the <a href="#">Getting help</a> section.</p> <p><b>NOTE:</b> For more information about the supported PCIe cards, see the Expansion cards and expansion card risers &gt; Expansion card installation guidelines section.</p>

## System health and system ID indicator codes

The system health and system ID indicator is located on the left control panel of the system.



Figure 10. System health and system ID indicator

Table 11. System health and system ID indicator codes

System health and system ID indicator code	Condition
Solid blue	Indicates that the system is powered on, is healthy, and system ID mode is not active. Press the system health and system ID button to switch to system ID mode.
Blinking blue	Indicates that the system ID mode is active. Press the system health and system ID button to switch to system health mode.
Solid amber	Indicates that the system is in fail-safe mode. If the problem persists, see the <a href="#">Getting help</a> section.
Blinking amber	Indicates that the system is experiencing a fault. Check the System Event Log for specific error messages. For information about the event and error messages generated by the system firmware and agents that monitor system components, go to <a href="#">QRL &gt; Look Up &gt; Error Code</a> , type the error code, and then click <b>Look it up</b> .

# Processor

## Topics:

- [Processor features](#)
- [Chipset](#)

## Processor features

The Intel 4<sup>th</sup> and 5<sup>th</sup> Generation Xeon® Scalable Processors stack is the next-generation data center processor offering with significant performance increases, integrated acceleration, and next-generation memory and I/O. Sapphire Rapids and Emerald Rapids accelerate customer usage with unique workload optimizations and provide the following feature improvements:

- Faster UPI with up to three Intel Ultra Path Interconnect (Intel UPI) at up to 20 GT/s, increasing multisocket bandwidth
- More, faster I/O with PCI Express 5 and up to 80 lanes (per socket)
- Enhanced Memory Performance with DDR5 support and memory speed up to 5200 MT/s in one DIMM per channel (1DPC)
- New onboard accelerators for data analytics, networking, storage, crypto, and data compression
- Enhanced security for virtualized environments with Intel Trust Domain Extensions (IntelR TDX) for confidential computing

## Supported processors

The following table shows the Intel Sapphire Rapids and Intel Emerald Rapids SKUs that are supported on the R660xs .

**Table 12. Supported Processors for R660xs**

Processor	Clock Speed (GHz)	Cache (M)	UPI (GT/s)	Cores	Threads	Turbo	Memory Speed (MT/s)	TDP
6534	3.9	22.5	20	8	16	Turbo	4800	195 W
6526Y	2.8	37.5	20	16	32	Turbo	5200	195 W
5512U	2.1	52.5	N/A	28	56	Turbo	4800	185 W
4514Y	2.0	30	16	16	32	Turbo	4400	150 W
4510	2.4	30	16	12	24	Turbo	4400	150 W
4509Y	2.6	23	16	8	16	Turbo	4400	125 W
6448Y	2.2	60	16	32	64	Turbo	4800	225 W
6442Y	2.6	60	16	24	48	Turbo	4800	225 W
6438Y+	2.0	60	16	32	64	Turbo	4800	205 W
6426Y	2.6	38	16	16	32	Turbo	4800	185 W
6414U	2.0	60	16	32	64	Turbo	4800	185 W
5420+	2.0	53	16	28	56	Turbo	4400	205 W
5418Y	2.0	45	16	24	48	Turbo	4400	185 W
5416S	2.0	30	16	16	32	Turbo	4400	150 W
5415+	2.9	23	16	8	16	Turbo	4400	150 W
5412U	2.1	45	16	24	48	Turbo	4400	185 W

**Table 12. Supported Processors for R660xs (continued)**

Processor	Clock Speed (GHz)	Cache (M)	UPI (GT/s)	Cores	Threads	Turbo	Memory Speed (MT/s)	TDP
4416+	2.0	38	16	20	40	Turbo	4000	165 W
4410Y	2.0	30	16	12	24	Turbo	4000	150 W
4410T	2.7	27	16	10	24	Turbo	4000	150 W
3408U	1.8	23	16	8	16	No Turbo	4000	125 W

## Chipset

The system supports Intel® C741 series chipset.

DMI - 3.0 speed (port width x8, x4)

USB ports - up to 10 superspeed (USB 3.1), 14 highspeed (USB 2.0)

SATA ports - up to 20 SATA port

PCIe Express - Up to 20 lanes, PCIe 3.0

## Chipset features

- PCI-E interfaces
  - Integrated PCI Express Gen5 for improved bandwidth and connectivity
  - Up to 80 lanes per processor
  - Connect PCIe x1 to iDRAC- integrated VGA chip
- Integrated USB - maximum of 10 SuperSpeed (USB 3.1), 14 highspeed (USB 2.0)
  - One front port (USB 2.0 / Right front I/O)
  - Two rear ports (USB 2.0/3.0)




# Memory subsystem

## Topics:

- Supported memory
- General memory module installation guidelines

## Supported memory

**Table 13. Memory technology comparison**


Feature	PowerEdge R660xs (DDR5)
DIMM type	RDIMM
Transfer speed	5200 MT/s(1DPC)  <b>NOTE:</b> Maximum DIMM transfer speed support dependent on CPU SKU and DIMM population
Voltage	1.1 V


**Table 14. Supported DIMMs**

DIMM PN	Rated DIMM Speed (MT/s)	DIMM Type	DIMM Capacity (GB)	Ranks per DIMM	Data Width	DIMM Volts (V)
1V1N1	4800	RDIMM	16	1	x8	1.1
W08W9	4800	RDIMM	32	2	x8	1.1
J52K5	4800	RDIMM	64	2	x4	1.1
5DR48	5600	RDIMM	16	1	x8	1.1
P8XPW	5600	RDIMM	32	2	x8	1.1
58F8N	5600	RDIMM	64	2	x4	1.1
FFX9N	5600	RDIMM	96	2	x4	1.1

**Table 15. Supported memory matrix**

DIMM type	Rank	Capacity	DIMM rated voltage and speed	Operating Speed
				1 DIMM per channel (DPC)
RDIMM	1 R	16 GB	DDR5 (1.1 V), 4800 MT/s DDR5 (1.1 V), 5600 MT/s	Up to 4800 MT/s Up to 5200 MT/s
	2 R	32 GB, 64 GB, 96 GB	DDR5 (1.1 V), 4800 MT/s DDR5 (1.1 V), 5600 MT/s	Up to 4800 MT/s Up to 5200 MT/s

 **NOTE:** 5600 MT/s RDIMMs are applicable for 5th Gen Intel® Xeon® Scalable Processors.


 **NOTE:** The processor may reduce the performance of the rated DIMM speed.

## General memory module installation guidelines

To ensure optimal performance of your system, observe the following general guidelines when configuring your system memory. If your system's memory configuration fails to observe these guidelines, your system might not boot, stop responding during memory configuration, or operate with reduced memory.

The memory bus may operate at speeds of 5200 MT/s, 4800 MT/s, 4400 MT/s or 4000 MT/s depending on the following factors:


- System profile selected (for example, Performance, Performance Per Watt Optimized (OS), or Custom [can be run at high speed or lower])
- Maximum supported DIMM speed of the processors
- Maximum supported speed of the DIMMs

 **NOTE:** MT/s indicates DIMM speed in MegaTransfers per second.


The system supports Flexible Memory Configuration, enabling the system to be configured and run in any valid chipset architectural configuration. The following are the recommended guidelines for installing memory modules:

- All DIMMs must be DDR5.
- Memory mixing is not supported for different DIMM capacities.
- If memory modules with different speeds are installed, they operate at the speed of the slowest installed memory module(s).
- Populate memory module sockets only if a processor is installed.
  - For single-processor systems, sockets A1 to A8 are available.
  - For dual-processor systems, sockets A1 to A8 and sockets B1 to B8 are available.
  - A minimum of 1 DIMM must be populated for each installed processor.
- In **Optimizer Mode**, the DRAM controllers operate independently in the 64-bit mode and provide optimized memory performance.

**Table 16. Memory population rules**

Processor	Configuration	Memory population	Memory population information
Single processor	Optimizer (Independent channel) population order	A{1}, A{2}, A{3}, A{4}, A{5}, A{6}, A{7}, A{8}	1, 2, 4, 6, 8 DIMMs are allowed.
Dual processor (Start with processor1. Processor 1 and processor 2 population should match)	Optimizer (Independent channel) population order	A{1}, B{1}, A{2}, B{2}, A{3}, B{3}, A{4}, B{4}, A{5}, B{5}, A{6}, B{6}, A{7}, B{7}, A{8}, B{8}	2, 4, 8, 12, 16 DIMMs are supported per system .  <b>NOTE:</b> Optimizer population order is not traditional for 8 and 16 DIMMs installations for dual processor.

- Always populate memory channels identically with equal DIMMs for best performance.
- Supported RDIMM configurations are 1, 2, 4, 6, and 8 DIMMs per processor.
- Supported 96 GB RDIMM configurations are 1, 6 and 8 DIMMs per processor.
- Populate eight equal memory modules per processor (one DIMM per channel) at a time to maximize performance.

 **NOTE:** Equal memory modules refer to DIMMs with identical electrical specification and capacity that may be from different vendors.

# Storage

## Topics:

- [Storage controllers](#)
- [Supported Drives](#)
- [External Storage](#)

## Storage controllers

Dell RAID controller options offer performance improvements, including the fPERC solution. fPERC provides a base RAID HW controller without consuming a PCIe slot by using a small form factor and high-density connector to the base planar.

16G PERC Controller offerings are a heavy leverage of 15G PERC family. The Value and Value Performance levels carry over to 16G from 15G. New to 16G is the Avenger-based Premium Performance tier offering. This high-end offering drives IOPs performance and enhanced SSD performance.

**Table 17. PERC Series controller offerings**

Performance Level	Controller and Description
Entry	S160
Value	H355, HBA465 (internal), HBA355 (internal/external)
Value Performance	H755, H755N
Premium Performance	H965i, Avenger 1 Memory: 8GB DDR4 NV cache 72-bit memory 2133 MHz Low profile form factors Dual A15 1.2 GHz CPU X8PCIe 3.0, x8 12Gb SAS

**NOTE:** For more information about the features of the Dell PowerEdge RAID controllers (PERC), Software RAID controllers, or BOSS card, and on deploying the cards, see the storage controller documentation at [Storage Controller Manuals](#).

**NOTE:** From December 2021, H355 replaces H345 as the entry raid controller. H345 is deprecated in January 2022.

## Storage controller feature matrix

**Table 18. Storage controller feature matrix**

Model & Form Factors	Interface Support	PCI Support	SAS Connection	Cache Memory Size	Write Back Cache	RAID Levels	Max Drive Support	RAID Support
PowerEdge Server-Storage Controllers (PERC) Series 12.2								

**Table 18. Storage controller feature matrix (continued)**

Model & Form Factors	Interface Support	PCI Support	SAS Connection	Cache Memory Size	Write Back Cache	RAID Levels	Max Drive Support	RAID Support
HBA465i Front	24Gb/s SAS 6Gb/s SAS/SATA	PCIe Gen 4	16 ports/lanes - 2x8 Internal	N/A	NA	N/A	16/ controller 50 with SAS Expander	N/A
PowerEdge Server-Storage Controllers (PERC) Series 12								
H965i Front	24Gb/s SAS 6Gb/s SAS/SATA Gen3 (8 GT/s) NVMe Gen4 (16 GT/s) NVMe	PCIe Gen 4	16 ports/lanes - 2x8 Internal	8GB NV	Flash Backed Cache	0,1,5,6,10,50,60	16	Hardware
H965i Adapter	24Gb/s SAS 6Gb/s SAS/SATA Gen3 (8 GT/s) NVMe Gen4 (16 GT/s) NVMe	PCIe Gen 4	16 ports/lanes - 2x8 Internal	8GB NV	Flash Backed Cache	0,1,5,6,10,50,60	16	Hardware
S160 Software RAID	Gen4 (16 GT/s) NVMe	PCIe Gen 4	N/A	No Cache	No Cache	0,1,5,10	8	Software RAID - Windows only
PowerEdge Server-Storage Controllers (PERC & SAS HBA) Series 11								
H755 Adapter	12Gb/s SAS 6Gb/s SAS/SATA 3Gb/s SAS/SATA Gen3 (8 GT/s) NVMe Gen4 (16 GT/s) NVMe	PCIe Gen 4	16 ports- 2x8 Internal	8GB NV	Flash Backed Cache	0,1,5,6,10,50,60	16/ controller 50 with SAS Expander	Hardware
H755N Front (NVMe Only)	Gen3 (8 GT/s) NVMe Gen4 (16 GT/s) NVMe	PCIe Gen 4	16 ports- 2x8 Internal	8GB NV	Flash Backed Cache	0,1,5,6,10,50,60	8/ controller	Hardware
H755 Front (SAS/SATA only)	12Gb/s SAS 6Gb/s SAS/SATA 3Gb/s SAS/SATA	PCIe Gen 4	16 ports- 2x8 Internal	8GB NV	Flash Backed Cache	0,1,5,6,10,50,60	16/ controller 50 with SAS Expander	Hardware
HBA355i Adapter	12Gb/s SAS 6Gb/s SAS/SATA 3Gb/s SAS/SATA	PCIe Gen 4	16 ports- 2x8 Internal	N/A	N/A	N/A	16/ controller 50 with SAS Expander	N/A

**Table 18. Storage controller feature matrix (continued)**

Model & Form Factors	Interface Support	PCI Support	SAS Connection	Cache Memory Size	Write Back Cache	RAID Levels	Max Drive Support	RAID Support
HBA355i Front	12Gb/s SAS 6Gb/s SAS/SATA 3Gb/s SAS/SATA	PCIe Gen 4	16 ports- 2x8 Internal	N/A	N/A	N/A	16/ controller 50 with SAS Expander	N/A
HBA355e Adapter	12Gb/s SAS 6Gb/s SAS/SATA 3Gb/s SAS/SATA	PCIe Gen 4	16 ports- 4x4 external	N/A	N/A	N/A	240	N/A
H355 Adapter	12Gb/s SAS 6Gb/s SAS/SATA	PCIe Gen 4	16 ports- 2x8 Internal	No Cache	No Cache	0,1, 10	Up to 32 RAID, or 32 Non- RAID	Hardware
H355 Front	12Gb/s SAS 6Gb/s SAS/SATA	PCIe Gen 4	16 ports- 2x8 Internal	No Cache	No Cache	0,1, 10	Up to 32 RAID, or 32 Non- RAID	Hardware

**NOTE:**

1. RAID 5/50 removed from entry RAID card
2. SWRAID support for Linux provides a pre-boot configuration utility to configure MDRAID and degraded boot capability.
3. For information, post-RTS, see the Storage controller documentation at [www.dell.com/stroagecontrollermanuals](http://www.dell.com/stroagecontrollermanuals).

This document is updated as changes happen, so for the latest version be sure to bookmark it rather than downloading an offline copy or refer to the [Storage Controller Matrix](#) on sales portal.

## Server storage controllers User Guide

- Server-Storage Controllers User's Guides, click [here](#)

## RAID - Redundant Array of Independent Disks

- Link to Help Me Choose: RAID Configuration [here](#)

## Datasheets and PERC performance scaling decks

- Resource Page for Server-Storage (Sales Portal) click [here](#)
- PERC & SAS HBA Datasheets (To be updated)

## Boot Optimized Storage Solution (BOSS)

BOSS is a RAID solution that is designed to boot operating systems and segregate operating system boot drives from data on server-internal storage.

## BOSS feature matrix

Table 19. BOSS feature matrix for 4 x 3.5-inch, 8 x 2.5-inch, 10 x 2.5-inch configurations

BOSS card	Drive Size	RAID levels	Stripe size	Virtual disk cache function	Maximum number of virtual disks	Maximum number of drives supported	Drive types	PCIe support	Disk cache policy	Support for Non-RAID disks	Cryptographic digital signature to verify firmware payload	Hot Plug
BOSS-N1 Modular	M.2 devices are read-intensive with 480 GB or 960 GB capacity	RAID1 and RAID0	Supports default 64K stripe size only	None	1	2	M.2 NVMe SSDs	Gen3	Drive default	No	Yes	No

### BOSS-N1

BOSS-N1 is offered as a means of booting 16G servers to a full OS when the target OS is a full OS (not just a hypervisor), or the user does not wish to trade off standard hot plug drive slots for OS install.

The HW RAID BOSS-N1 card is a RAID controller with a limited feature set that presents M.2 NVMe-only SSDs as either a RAID0 disk or a single RAID1 volume with 2 disks. BOSS-N1 enables support for 480/960 GB Disks from Factory Install.

Hardware: BOSS-N1 Controller for 4 x 3.5-inch, 8 x 2.5-inch, 10 x 2.5-inch configurations

Reliability: Enterprise-Class M.2 NVMe SSDs

Supports dual 80 mm, Read Intensive (1DWP), M.2 devices 480 GB/960 GB Standard - 1.92 TB QNS

Accessibility: Internal for 4 x 3.5-inch, 8 x 2.5-inch, 10 x 2.5-inch configurations

Serviceability: Cold-swap for 4 x 3.5-inch, 8 x 2.5-inch, 10 x 2.5-inch configurations

Supports Hardware RAID1 and RAID0

Supports UEFI boot

Marvell 88NR2241 NVMe RAID Controller

Controlled Firmware Upgrade through iDRAC



Figure 11. BOSS-N1 Controller for 4 x 3.5-inch, 8 x 2.5-inch, 10 x 2.5-inch configurations

## Datasheets

- [BOSS-N1](#) (to be updated)

## BOSS User Guides

- [BOSS-N1](#)

## Supported Drives

The table shown below lists the internal drives supported by the R660xs. Refer to Agile for the latest SDL

**Table 20. Supported Drives**

Form Factor	Type	Speed	Rotational Speed	Capacities
2.5 inches	vSAS	12 Gb	SSD	1.92 TB, 3.84 TB, 960 GB, 7.62 TB
2.5 inches	SAS	24 Gb	SSD	1.92 TB, 1.6 TB, 800 GB, 3.84 TB, 960 GB, 7.68 TB
2.5 inches	SATA	6 Gb	SSD	1.92 TB, 480 GB, 960 GB, 3.84 TB
2.5 inches	NVMe	Gen4	SSD	1.6 TB, 3.2 TB, 6.4 TB, 1.92 TB, 3.84 TB, 15.63 TB, 7.68 TB
2.5 inches	DC NVMe	Gen4	SSD	3.84 TB, 960 GB
2.5 inches	SAS	12 Gb	10 K	600 GB, 1.2 TB, 2.4 TB
3.5 inches	SATA	6 Gb	7.2 K	2 TB, 4 TB, 8 TB, 12 TB, 16 TB, 20 TB, 24 TB
3.5 inches	SAS	12 Gb	7.2 K	2 TB, 4 TB, 8 TB, 12 TB, 16 TB, 20 TB, 24 TB

## External Storage

The R660xs support the external storage device types listed in the table below.

**Table 21. Support External Storage Devices**

Device Type	Description
External Tape	Supports connection to external USB tape products
NAS/IDM appliance software	Supports NAS software stack
JBOD	Supports connection to 12 Gb MD-series JBODs

# Networking

## Topics:

- [Overview](#)
- [OCP 3.0 support](#)

## Overview

PowerEdge offers a wide variety of options to get information moving to and from our servers. Industry best technologies are chosen, and systems management features are added by our partners to firmware to tie in with iDRAC. These adapters are rigorously validated for worry-free, fully supported use in Dell servers.

## OCP 3.0 support

**Table 22. OCP 3.0 feature list**

Feature	OCP 3.0
Form factor	SFF
PCIe Gen	Gen4
Max PCIe width	x8
Max no. of ports	4
Port type	BT/SFP/SFP+/SFP28/SFP56
Max port speed	25 GbE
NC-SI	Yes
WoL	Yes
Power consumption	15 W–35 W

## Supported OCP cards

**Table 23. Supported OCP cards**

Form factor	Vendor	Port speed	Port type	Port count
OCP 3.0	Broadcom	10 GbE	BT	2
		25 GbE	SFP28	2
		25 GbE	SFP28	4
		1 GbE	BT	4
		10 GbE	BT	4
	Intel	1 GbE	BT	4
		10 GbE	BT	2



**Table 23. Supported OCP cards (continued)**

Form factor	Vendor	Port speed	Port type	Port count
		10 GbE	BT	4
		25 GbE	SFP28	2
		25 GbE	SFP28	4

## OCP NIC 3.0 vs. rack Network Daughter Card comparisons

**Table 24. OCP 3.0, 2.0, and rNDC NIC comparison**

Form Factor	Dell rNDC	OCP 2.0 (LOM Mezz)	OCP 3.0	Notes
PCIe Gen	Gen 3	Gen 3	Gen 4	Supported OCP3 are SFF (small form factor)
Max PCIe Lanes	x8	Up to x16	Up to x8	See server slot priority matrix
Shared LOM	Yes	Yes	Yes	This is iDRAC port redirect
Aux Power	Yes	Yes	Yes	Used for Shared LOM

## Slot priority matrix

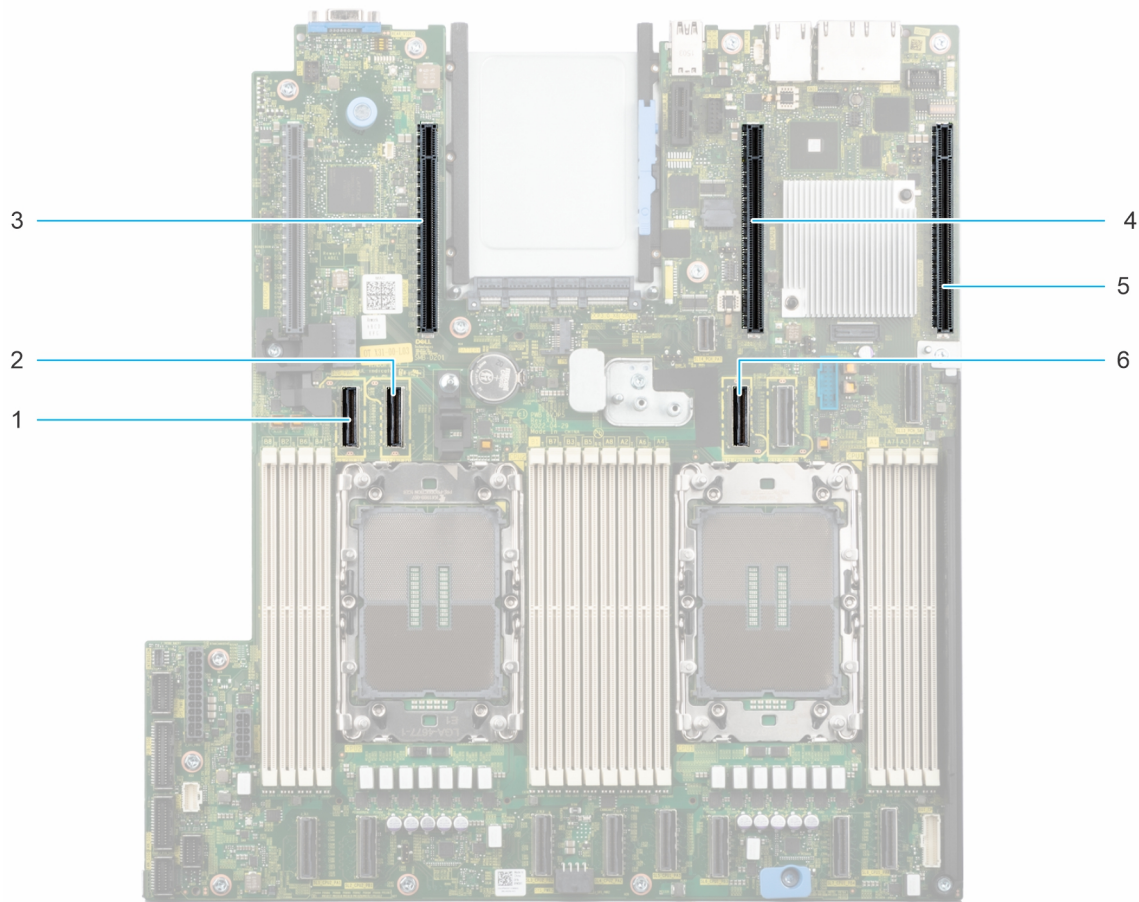
For add-in cards that can be mapped to the R660xs and guidelines for installing expansion cards, see the R660xs slot priority matrix file on Sales Portal.

Link:<https://www.delltechnologies.com/resources/en-us/auth/products/servers/category.htm>

### Topics:

- [Expansion card installation guidelines](#)

## Expansion card installation guidelines



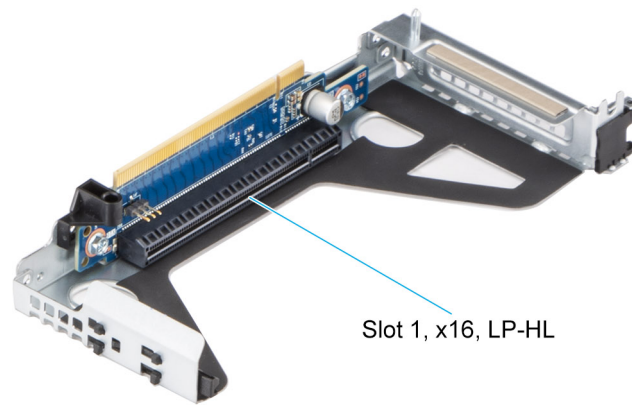
**Figure 12. Expansion card slot connectors**

- |                             |                                 |
|-----------------------------|---------------------------------|
| 1. Riser 2E cable connector | 2. Riser 2E cable connector     |
| 3. Riser 2 connector        | 4. BOSS riser connector         |
| 5. Riser 1 connector        | 6. Riser 1B, 2D cable connector |

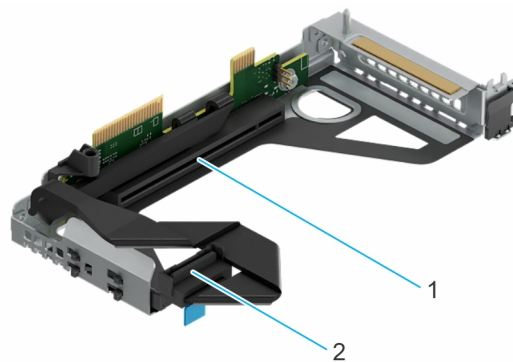
The following table describes the expansion card riser configurations:

**Table 25. Expansion card riser configurations**

Configurations	Expansion card risers	PCIe Slots	Controlling processor	Height	Length	Slot width
Config0.	No riser	NA	NA	NA	NA	NA
Config1. with 3x LP	R1a	1	Processor 1	Low Profile	Half length	x16
	R2a	2 and 3	Processor 2	Low Profile	Half length	x8 + x8
Config2. with 2x LP	R1a	1	Processor 1	Low Profile	Half length	x16
	R2e	2 (Gen5)	Processor 2	Low Profile	Half length	x16
Config3. with 1x LP	R1a	1	Processor 1	Low Profile	Half length	x16
Config4. with 1x LP	R1a + Rear drives	1	Processor 1	Low Profile	Half length	x16
Config5. with 2x LP	R1a	1	Processor 1	Low Profile	Half length	x16
	R2d	2 (Gen5)	Processor 1	Low Profile	Half length	x8
Config6. with 2x LP	R1b	1	Processor 1	Low Profile	Half length	x8
	R2e	2	Processor 2	Low Profile	Half length	x16

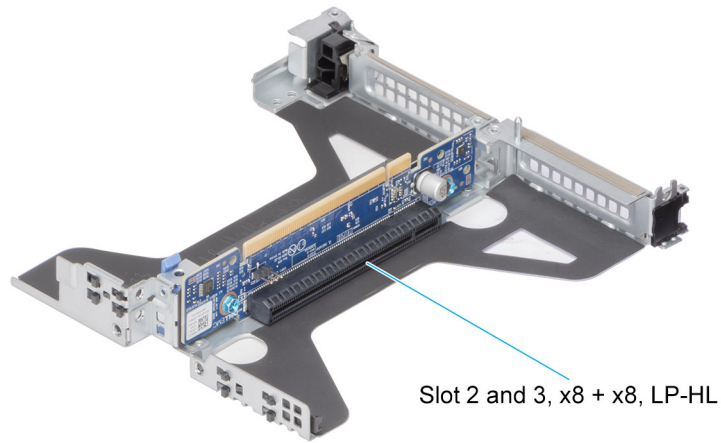


**Figure 13. Riser 1a**

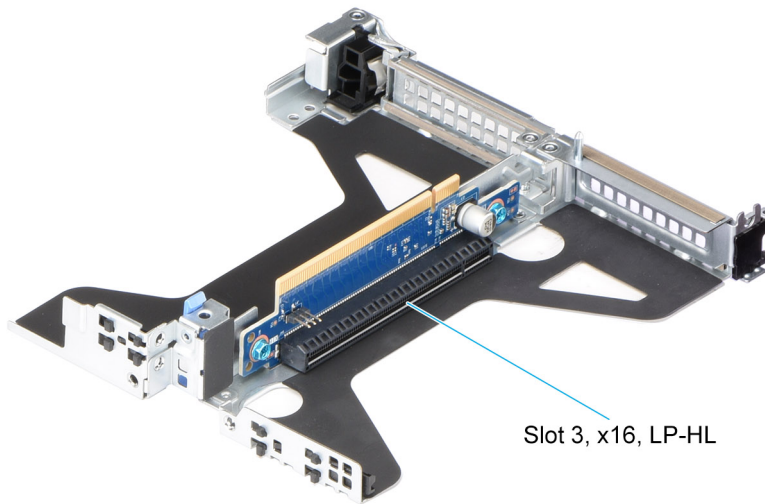


**Figure 14. Riser 1b**

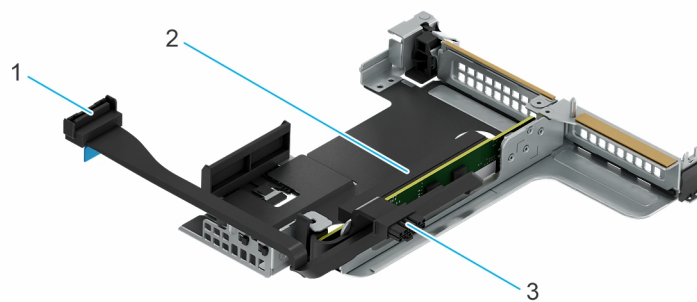
1. Slot 1, x8, LP-HL
2. Signal cable connector



**Figure 15. Riser 2a**

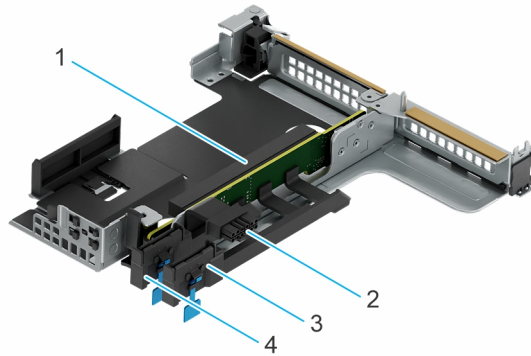


**Figure 16. Riser 2c**



**Figure 17. Riser 2d**

1. Signal cable connector
2. Slot 2, x8, LP-HL
3. Power cable connector



**Figure 18. Riser 2e**

- 1. Slot 2, x16, LP-HL
- 2. Power cable connector
- 3. Signal cable connector
- 4. Signal cable connector

**NOTE:** The expansion-card slots are not hot-swappable.

The following table provides guidelines for installing expansion cards to ensure proper cooling and mechanical fit. The expansion cards with the highest priority should be installed first using the slot priority indicated. All the other expansion cards should be installed in the card priority and slot priority order.

**Table 26. Configuration 0: No Riser**

Card type	Slot priority	Maximum number of cards
Foxconn Front PERC 12/11	Integrated slot	1
Intel (OCP: 100Gb)	Integrated slot	1
Mellanox (OCP: 100Gb)	Integrated slot	1
Broadcom (OCP: 25Gb)	Integrated slot	1
Intel (OCP: 25Gb)	Integrated slot	1
Broadcom (OCP: 10Gb)	Integrated slot	1
Broadcom (OCP: 1Gb)	Integrated slot	1
Dell BOSS N1 Module	Integrated slot	1

**Table 27. Configuration 1: R1a+ R2a**

Card type	Slot priority	Maximum number of cards
Inventec Serial port module (LP)	2	1
Foxconn Front PERC 12/11	Integrated slot	1
Intel (OCP: 100Gb)	Integrated slot	1
Mellanox (OCP: 100Gb)	Integrated slot	1
Broadcom (OCP: 25Gb)	Integrated slot	1
Intel (OCP: 25Gb)	Integrated slot	1
Broadcom (OCP: 10Gb)	Integrated slot	1
Broadcom (OCP: 1Gb)	Integrated slot	1
Dell BOSS N1 Module	Integrated slot	1
Mellanox (NIC: HDR100 VPI)	1	1
Mellanox (NIC: HDR VPI)	1	1

**Table 27. Configuration 1: R1a+ R2a (continued)**

Card type	Slot priority	Maximum number of cards
Mellanox (NIC: 100Gb)	1	1
Broadcom (NIC: 100Gb)	1	1
Intel (NIC: 100Gb)	1	1
Mellanox (NIC: 25Gb)	1	1
Mellanox (NIC: 25Gb)	3, 1, 2	3
Intel (NIC: 25Gb)	3, 1, 2	3
Broadcom (HBA: FC64)	3, 1, 2	3
Broadcom (HBA: FC32)	3, 1, 2	3
Qlogic (Marvell) (HBA: FC32)	3, 1, 2	3
Broadcom (NIC: 25Gb)	3, 1, 2	3
Broadcom (NIC: 10Gb)	3, 1, 2	3
Intel (NIC: 10Gb)	3, 1, 2	3
Intel(NIC: 1Gb)	3, 1, 2	3
Broadcom (NIC: 1Gb)	3, 1, 2	3
Foxconn External PERC Adapter	3, 1, 2	3

**Table 28. Configuration 2: R1a+R2e**

Card type	Slot priority	Maximum number of cards
Inventec Serial port module (LP)	3	1
Foxconn Front PERC 12/11	Integrated slot	1
Intel (OCP: 100Gb)	Integrated slot	1
Mellanox (OCP: 100Gb)	Integrated slot	1
Broadcom (OCP: 25Gb)	Integrated slot	1
Intel (OCP: 25Gb)	Integrated slot	1
Broadcom (OCP: 10Gb)	Integrated slot	1
Broadcom (OCP: 1Gb)	Integrated slot	1
Dell BOSS N1 Module	Integrated slot	1
Mellanox (NIC: NDR100)	2	1
Mellanox (NIC: NDR200)	2	1
Mellanox (NIC: HDR100 VPI)	2,1	2
Mellanox (NIC: HDR VPI)	2,1	2
Mellanox (NIC: 100Gb)	2,1	2
Broadcom (NIC: 100Gb)	2,1	2
Intel (NIC: 100Gb)	2,1	2
Mellanox (NIC: 25Gb)	2,1	2
Intel (NIC: 25Gb)	2,1	2
Broadcom (HBA: FC64)	2,1	2
Broadcom (HBA: FC32)	2,1	2

**Table 28. Configuration 2: R1a+R2e (continued)**

Card type	Slot priority	Maximum number of cards
Qlogic (Marvell) (HBA: FC32)	2,1	2
Broadcom (NIC: 25Gb)	2,1	2
Broadcom (NIC: 10Gb)	2,1	2
Intel (NIC: 10Gb)	2,1	2
Intel(NIC: 1Gb)	2,1	2
Broadcom (NIC: 1Gb)	2,1	2
Foxconn External PERC Adapter	2,1	2

**Table 29. Configuration 3: R1a**

Card type	Slot priority	Maximum number of cards
Inventec Serial port module (LP)	1	1
Foxconn Front PERC 12/11	Integrated slot	1
Intel (OCP: 100Gb)	Integrated slot	1
Mellanox (OCP: 100Gb)	Integrated slot	1
Broadcom (OCP: 25Gb)	Integrated slot	1
Intel (OCP: 25Gb)	Integrated slot	1
Broadcom (OCP: 10Gb)	Integrated slot	1
Broadcom (OCP: 1Gb)	Integrated slot	1
Dell BOSS N1 Module	Integrated slot	1
Mellanox (NIC: HDR100 VPI)	1	1
Mellanox (NIC: HDR VPI)	1	1
Mellanox (NIC: 100Gb)	1	1
Broadcom (NIC: 100Gb)	1	1
Intel (NIC: 100Gb)	1	1
Mellanox (NIC: 25Gb)	1	1
Intel (NIC: 25Gb)	1	1
Broadcom (HBA: FC64)	1	1
Broadcom (HBA: FC32)	1	1
Qlogic (Marvell) (HBA: FC32)	1	1
Broadcom (NIC: 25Gb)	1	1
Broadcom (NIC: 10Gb)	1	1
Intel (NIC: 10Gb)	1	1
Intel(NIC: 1Gb)	1	1
Broadcom (NIC: 1Gb)	1	1
Foxconn External PERC Adapter	1	1

**Table 30. Configuration 4: R1a+Rear drives**

Card type	Slot priority	Maximum number of cards
Inventec Serial port module (LP)	1	1

**Table 30. Configuration 4: R1a+Rear drives (continued)**

Card type	Slot priority	Maximum number of cards
Foxconn Front PERC 12/11	Integrated slot	1
Intel (OCP: 100Gb)	Integrated slot	1
Mellanox (OCP: 100Gb)	Integrated slot	1
Broadcom (OCP: 25Gb)	Integrated slot	1
Intel (OCP: 25Gb)	Integrated slot	1
Broadcom (OCP: 10Gb)	Integrated slot	1
Broadcom (OCP: 1Gb)	Integrated slot	1
Dell BOSS N1 Module	Integrated slot	1
Mellanox (NIC: HDR100 VPI)	1	1
Mellanox (NIC: HDR VPI)	1	1
Mellanox (NIC: 100Gb)	1	1
Broadcom (NIC: 100Gb)	1	1
Intel (NIC: 100Gb)	1	1
Mellanox (NIC: 25Gb)	1	1
Intel (NIC: 25Gb)	1	1
Broadcom (HBA: FC64)	1	1
Broadcom (HBA: FC32)	1	1
Qlogic (Marvell) (HBA: FC32)	1	1
Broadcom (NIC: 25Gb)	1	1
Broadcom (NIC: 10Gb)	1	1
Intel (NIC: 10Gb)	1	1
Intel(NIC: 1Gb)	1	1
Broadcom (NIC: 1Gb)	1	1
Foxconn External PERC Adapter	1	1

**Table 31. Configuration 5: R1a+R2d**

Card type	Slot priority	Maximum number of cards
Inventec Serial port module (LP)	3	1
Foxconn Front PERC 12/11	Integrated slot	1
Intel (OCP: 100Gb)	Integrated slot	1
Mellanox (OCP: 100Gb)	Integrated slot	1
Broadcom (OCP: 25Gb)	Integrated slot	1
Intel (OCP: 25Gb)	Integrated slot	1
Broadcom (OCP: 10Gb)	Integrated slot	1
Broadcom (OCP: 1Gb)	Integrated slot	1
Dell BOSS N1 Module	Integrated slot	1
Mellanox (NIC: HDR100 VPI)	1	1
Mellanox (NIC: HDR VPI)	1	1



**Table 31. Configuration 5: R1a+R2d (continued)**

Card type	Slot priority	Maximum number of cards
Mellanox (NIC: 100Gb)	1	1
Broadcom (NIC: 100Gb)	1	1
Intel (NIC: 100Gb)	1	1
Mellanox (NIC: 25Gb)	1	1
Mellanox (NIC: 25Gb)	2,1	2
Intel (NIC: 25Gb)	2,1	2
Broadcom (HBA: FC64)	2,1	2
Broadcom (HBA: FC32)	2,1	2
Qlogic (Marvell) (HBA: FC32)	2,1	2
Broadcom (NIC: 25Gb)	2,1	2
Broadcom (NIC: 10Gb)	2,1	2
Intel (NIC: 10Gb)	2,1	2
Intel(NIC: 1Gb)	2,1	2
Broadcom (NIC: 1Gb)	2,1	2
Foxconn External PERC Adapter	2,1	2

**Table 32. Configuration 6: R1b+R2e**

Card type	Slot priority	Maximum number of cards
Inventec Serial port module (LP)	3	1
Foxconn Front PERC 12/11	Integrated slot	1
Intel (OCP: 100Gb)	Integrated slot	1
Mellanox (OCP: 100Gb)	Integrated slot	1
Broadcom (OCP: 25Gb)	Integrated slot	1
Intel (OCP: 25Gb)	Integrated slot	1
Broadcom (OCP: 10Gb)	Integrated slot	1
Broadcom (OCP: 1Gb)	Integrated slot	1
Dell BOSS N1 Module	Integrated slot	1
Mellanox (NIC: NDR100)	2	1
Mellanox (NIC: NDR200)	2	1
Mellanox (NIC: HDR100 VPI)	2	1
Mellanox (NIC: HDR VPI)	2	1
Mellanox (NIC: 100Gb)	2	1
Broadcom (NIC: 100Gb)	2	1
Intel (NIC: 100Gb)	2	1
Mellanox (NIC: 25Gb)	2	1
Mellanox (NIC: 25Gb)	2,1	2
Intel (NIC: 25Gb)	2,1	2
Broadcom (HBA: FC64)	2,1	2

**Table 32. Configuration 6: R1b+R2e (continued)**

<b>Card type</b>	<b>Slot priority</b>	<b>Maximum number of cards</b>
Broadcom (HBA: FC32)	2,1	2
Qlogic (Marvell) (HBA: FC32)	2,1	2
Broadcom (NIC: 25Gb)	2,1	2
Broadcom (NIC: 10Gb)	2,1	2
Intel (NIC: 10Gb)	2,1	2
Intel(NIC: 1Gb)	2,1	2
Broadcom (NIC: 1Gb)	2,1	2
Foxconn External PERC Adapter	2,1	2

# Power, thermal, and acoustics

PowerEdge servers have an extensive collection of sensors that automatically track thermal activity, which helps to regulate temperature by reducing server noise and power consumption. The table below lists the tools and technologies Dell offers to lower power consumption and increase energy efficiency.

## Topics:

- [Power](#)
- [Thermal](#)
- [Acoustics](#)

## Power

**Table 33. Power tools and technologies**

Feature	Description
Power Supply Units(PSU) portfolio	Dell's PSU portfolio includes intelligent features such as dynamically optimizing efficiency while maintaining availability and redundancy. Find additional information in the Power supply units section.
Tools for right sizing	Enterprise Infrastructure Planning Tool (EIPT) is a tool that can help you determine the most efficient configuration possible. With Dell's EIPT, you can calculate the power consumption of your hardware, power infrastructure, and storage at a given workload. Learn more at <a href="http://www.dell.com/calc">www.dell.com/calc</a> .
Industry Compliance	Dell's servers are compliant with all relevant industry certifications and guide lines, including 80 PLUS, Climate Savers and ENERGY STAR.
Power monitoring accuracy	PSU power monitoring improvements include: <ul style="list-style-type: none"> <li>• Dell's power monitoring accuracy is currently 1%, whereas the industry standard is 5%</li> <li>• More accurate reporting of power</li> <li>• Better performance under a power cap</li> </ul>
Power capping	Use Dell's systems management to set the power cap limit for your systems to limit the output of a PSU and reduce system power consumption. Dell is the first hardware vendor to leverage Intel Node Manager for circuit-breaker fast capping.
Systems Management	iDRAC Enterprise and Datacenter provides server-level management that monitors, reports and controls power consumption at the processor, memory and system level.  Dell OpenManage Power Center delivers group power management at the rack, row, and data center level for servers, power distribution units, and uninterruptible power supplies.
Active power management	Intel Node Manager is an embedded technology that provides individual server-level power reporting and power limiting functionality. Dell offers a complete power management solution comprised of Intel Node Manager accessed through Dell iDRAC9 Datacenter and OpenManage Power Center that allows policy-based management of power and thermal at the individual server, rack, and data center level. Hot spare reduces power consumption of redundant power supplies. Thermal control off a speed optimizes the thermal settings for your environment to reduce fan consumption and lower system power consumption.  Idle power enables Dell servers to run as efficiently when idle as when at full workload.
Rack infrastructure	Dell offers some of the industry's highest-efficiency power infrastructure solutions, including:

**Table 33. Power tools and technologies (continued)**

Feature	Description
	<ul style="list-style-type: none"> <li>Power distribution units (PDUs)</li> <li>Uninterruptible power supplies (UPSs)</li> <li>Energy Smart containment rack enclosures</li> </ul> Find additional information at: <a href="https://www.delltechnologies.com/en-us/servers/power-and-cooling.htm">https://www.delltechnologies.com/en-us/servers/power-and-cooling.htm</a> .

## PSU specifications

The PowerEdge R660xs system supports up to two AC or DC power supply units (PSUs).

**Table 34. R660xs PSU specifications**

PSU	Class	Heat dissipation (maximum) (BTU/hr)	Frequency (Hz)	AC Voltage			DC Voltage			Current (A)
				100–120 V	200–240 V	277 V	240 V	336 V	- (48 V – 60 V)	
600 W mixed mode	Platinum	2250	50/60	600 W	600 W	N/A	N/A	N/A	N/A	7.1 A - 3.6 A
	N/A		N/A	N/A	N/A	N/A	600 W	N/A	N/A	2.9 A
700 W mixed mode HLAC	Titanium	2625	50/60	N/A	700 W	N/A	N/A	N/A	N/A	4.1 A
	N/A		N/A	N/A	N/A	N/A	700 W	N/A	N/A	3.4 A
800 W mixed mode	Platinum	3000	50/60	800 W	800 W	N/A	N/A	N/A	N/A	9.2 A - 4.7 A
	N/A		N/A	N/A	N/A	N/A	800 W	N/A	N/A	3.8 A
1100 W -48 V DC	N/A	4265	N/A	N/A	N/A	N/A	N/A	N/A	1100 W	27 A
1100 W mixed mode	Titanium	4125	50/60	1050 W	1100 W	N/A	N/A	N/A	N/A	12 A - 6.3 A
	N/A		N/A	N/A	N/A	N/A	1100 W	N/A	N/A	5.2 A
1400 W mixed mode	Titanium	5250	50/60	1050 W	1400 W	N/A	N/A	N/A	N/A	12 A - 8 A
	N/A		N/A	N/A	N/A	N/A	1400 W	N/A	N/A	6.5 A
1400 W mixed mode	Platinum	5250	50/60	1050 W	1400 W	N/A	N/A	N/A	N/A	12 A - 8 A
	N/A		N/A	N/A	N/A	N/A	1400 W	N/A	N/A	6.6 A
1400 W 277 V AC and HVDC	Titanium	5250	50/60	N/A	N/A	1400 W	N/A	N/A	N/A	5.8 A
		5250	N/A	N/A	N/A	N/A	N/A	1400 W	N/A	5.17 A
1800 W mixed mode HLAC	Titanium	6610	50/60	N/A	1800 W	N/A	N/A	N/A	N/A	10 A
	N/A		N/A	N/A	N/A	N/A	1800 W	N/A	N/A	8.2 A

**NOTE:** Heat dissipation is calculated using the PSU wattage rating.

**NOTE:** HLAC stands for High-Line AC, with a range of 200 - 240V AC. HVDC stands for High-Voltage DC, with 336V DC.

**NOTE:** When selecting or upgrading the system configuration, to ensure optimum power utilization, verify the system power consumption with the Enterprise Infrastructure Planning Tool available at [calc](#).

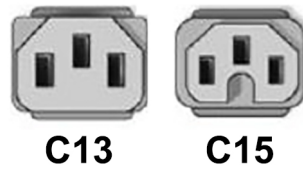


Figure 19. PSU power cords

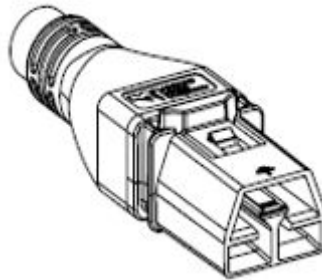


Figure 20. APP 2006G1 power cord

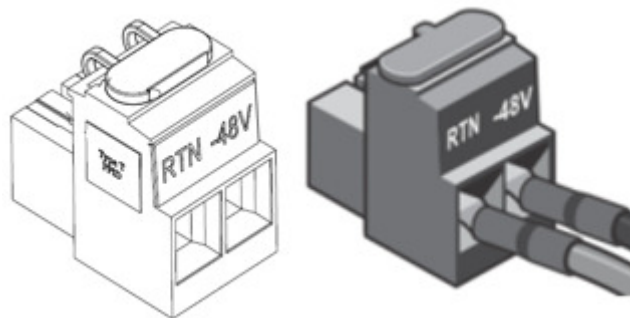


Figure 21. Lotes DC PSU connector

Table 35. PSU power cords

Form factor	Output	Power cord
Redundant 60 mm	600 W Mixed Mode	C13
	700 W Mixed Mode HLAC	C13
	800 W Mixed Mode	C13
	1100 W Mixed Mode	C13
	1100 W -48 V DC	Lotes DC PSU connector
	1400 W Mixed Mode	C13
	1400 W 277 VAC and HVDC	APP 2006G1
	1800 W Mixed Mode HLAC	C15

**NOTE:** C13 power cord combined with C14 to C15 jumper power cord can be used to adapt 1800 W PSU.

# Thermal

PowerEdge servers have an extensive collection of sensors that automatically track thermal activity, which helps regulate temperature thereby reducing server noise and power consumption.

# Acoustics

## Acoustical configurations

Dell PowerEdge R660xs is a rack server appropriate for attended data center environment. However, lower acoustical output is attainable with proper hardware or software configurations.

**Table 36. Configurations tested for acoustical experience**

Configuration	Quiet	VOLUME 1 - 2.5-inch	VOLUME 2 - 3.5-inch with Rear Storage
CPU Type	Intel Sapphire Rapids	Intel Sapphire Rapids	Intel Sapphire Rapids
CPU TDP	125 W / 8C	185 W / 16C	185 W / 16C
CPU Quantity	1	2	2
RDIMM Memory	16 GB DDR5	16 GB DDR5	32 GB DDR5
Memory Quantity	2	16	16
Backplane Type	10 x 2.5-inch BP	10 x 2.5-inch BP	4 x 3.5-inch BP
HDD Type	2.5-inch SAS 600G	NVMe 1.6T	2.5-inch SATA 12T+NVMe 1.6T rear
HDD Quantity	2	8	4+2
PSU Type	600 W	800 W	1400 W
PSU Quantity	1	2	2
M.2	X	BOSS-N1	BOSS-N1
OCP	OCP(3.0)-4 port NIC Card(1G)	Dual Port 10GbE	Dual Port 25GbE
PCI 1	X	LP 25Gb 2-port Networking card	LP 25Gb 2-port Networking card
PCI 2	X	LP 25Gb 2-port Networking card	X
Front PERC	HBA355I	X	H755
LOM Card	X	X	X
PERC	X	X	X

**Table 37. Acoustical experience of R660xs configurations**

Configuration	Quiet	VOLUME 1 - 2.5-inch	VOLUME 2 - 3.5-inch with Rear Storage
Acoustical Performance: Idle/ Operating @ 25°C Ambient			
L <sub>WA,m</sub> (B)	Idle <sup>(4)</sup>	4.9	5.5
	Operating <sup>(5)</sup>	5.0	6.1
K <sub>v</sub> (B)	Idle <sup>(4)</sup>	0.4	0.4

**Table 37. Acoustical experience of R660xs configurations (continued)**

Configuration		Quiet	VOLUME 1 - 2.5-inch	VOLUME 2 - 3.5-inch with Rear Storage
	Operating <sup>(5)</sup>	0.4	0.4	0.4
L <sub>pA,m</sub> (dB)	Idle <sup>(4)</sup>	32	40	40
	Operating <sup>(5)</sup>	34	45	40
Prominent tones		No prominent tones in Idle and Operating		
Acoustical Performance: Idle @ 28°C Ambient				
L <sub>wA,m</sub> <sup>(1)</sup> (B)		5.1	5.8	5.9
K <sub>v</sub> (B)		0.4	0.4	0.4
L <sub>pA,m</sub> <sup>(2)</sup> (dB)		34	43	44
Acoustical Performance: Max. loading @ 35°C Ambient				
L <sub>wA,m</sub> <sup>(1)</sup> (B)		6.5	7.2	7.3
K <sub>v</sub> (B)		0.4	0.4	0.4
L <sub>pA,m</sub> <sup>(2)</sup> (dB)		48	56	57

<sup>(1)</sup>L<sub>wA,m</sub>: The declared mean A-weighted sound power level (L<sub>wA</sub>) is calculated per section 5.2 of ISO 9296 (2017) with data collected using the methods that are described in ISO 7779 (2010). Engineering data presented here may not be fully compliant with ISO 7779 declaration requirement.

<sup>(2)</sup>L<sub>pA,m</sub>: The declared mean A-weighted emission sound pressure level is at the bystander position per section 5.3 of ISO 9296 (2017) and measured using methods that are described in ISO 7779 (2010). The system is placed in a 24U rack enclosure, 25 cm above a reflective floor. Engineering data presented here may not be fully compliant with ISO 7779 declaration requirement.

<sup>(3)</sup>Prominent tones: Criteria of Annex D of ECMA-74 and Prominence Ratio method of ECMA-418 are followed to determine if discrete tones are prominent and to report them, if so.

<sup>(4)</sup>Idle mode: The steady-state condition in which the server is energized but not operating any intended function.

<sup>(5)</sup>Operating mode: The maximum of the steady state acoustical output at 50% of CPU TDP or active storage drives for the respective sections of Annex C of ECMA-74.

# Rack, rails, and cable management

## Topics:

- [Rails information](#)
- [Cable Management Arm](#)
- [Strain Relief Bar](#)
- [Rack Installation](#)

## Rails information

The rail offerings for the R660xs consist of two general types: sliding and static. The cable management offerings consist of an optional cable management arm (CMA) and an strain relief bar (SRB).

See the *Dell Enterprise Systems Rail Sizing and Rack Compatibility Matrix* available at [rail-rack-matrix](#) for information regarding:

- Specific details about rail types.
- Rail adjustability ranges for various rack mounting flange types
- Rail depth with and without cable management accessories
- Rack types that are supported for various rack mounting flange types

Key factors governing proper rail selection include the following:

- Identifying the type of rack in which they will be installed.
- The spacing between the front and rear mounting flanges of the rack.
- The type and location of any equipment mounted in the back of the rack such as power distribution units (PDUs), and the overall depth of the rack
- Overall depth of the rack

## A11 Sliding Rails features summary

The sliding rails allow the system to be fully extended out of the rack for service. The sliding rails have a Cable Management Arm (CMA) and a Strain Relief Bar (SRB) option.

There are one types of sliding rails available:

- Stab-in/Drop-in sliding rails

### A11 Stab-in/Drop-in sliding rails for 4-post racks

- Supports Drop-in or Stab-in installation of the chassis to the rails
- Supports tool-less installation in 19-inch EIA-310-E compliant square, unthreaded round hole racks including all generations of Dell racks.

Also supports tool-less installation in threaded round hole 4-post racks

- Support for tool-less installation in Dell Titan or Titan-D racks
- Supports full extension of the system out of the rack to allow serviceability of key internal components
- **i** **NOTE:** For situations where CMA support is not required, the outer CMA mounting brackets can be uninstalled from the sliding rails. This reduces the overall length of the rails and eliminates the potential interferences with rear mounted PDUs or the rear rack door.

Supports optional Cable Management Arm (CMA)

- Supports optional Strain Relief Bar (SRB)



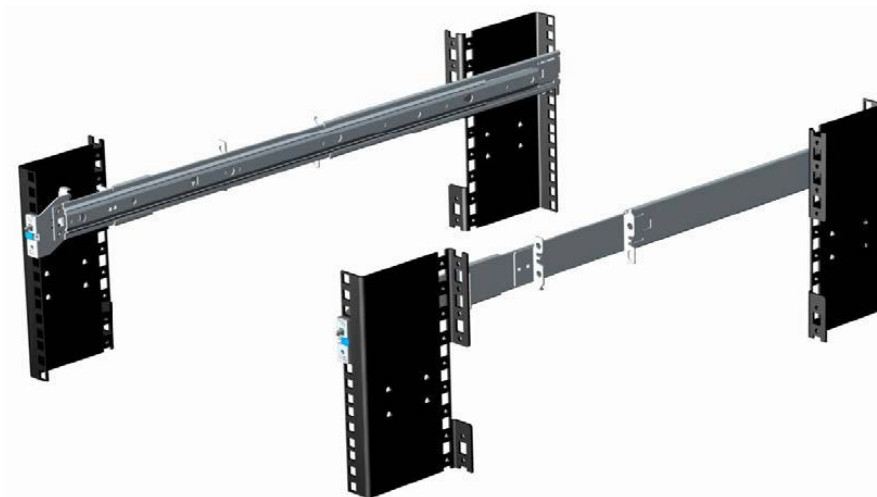
## A8 Static Rails features summary

The static rails, which are shown in the figure below, support a wider variety of racks than the sliding rails, but do not support serviceability in the rack. The static rails are not compatible with the CMA and SRB.

- Supports Stab-in installation of the chassis to the rails
- Supports tool-less installation in 19-inch EIA-310-E compliant square or unthreaded round hole 4-post racks including all generations of Dell racks
- Supports tooled installation in 19-inch EIA-310-E compliant threaded hole 4-post and 2-post racks
- Supports tooled installation in Dell Titan or Titan-D rack

### **i** NOTE:

- Screws are not included with the static rail kit since racks are offered with various thread types.
- Screw head diameter should be 10mm or less.



**Figure 22. Static rails**

### **2-Post racks installation**

If installing to 2-Post (Telco) racks, the ReadyRails II static rails (A8) must be used. Sliding rails support mounting in 4-post racks only.



**Figure 23. Static rails in 2-post center mount configuration**

### Installation in the Dell Titan or Titan-D racks

For tool-less installation in Titan or Titan-D racks, the Stab-in/Drop-in sliding rails (A11) must be used. This rail collapses down sufficiently to fit in the rack with mounting flanges that are spaced about 24 inches apart from front to back. The Stab-in/Drop-in sliding rail allows bezels of the servers and storage systems to be aligned when installed in these racks. For tooled installation, Stab-in Static rails (A8) must be used for bezel alignment with storage systems.

## Cable Management Arm

The optional Cable Management Arm (CMA) for the system organizes and secures the cords and cables exiting the back of the server and unfolds to allow the server to extend out of the rack without having to detach the cables.

Some key features of the CMA include:

- Large U-shaped baskets to support dense cable loads
- Open vent pattern for optimal airflow
- Support for mounting on either side by swinging the spring-loaded brackets from one side to the other
- Utilizes hook-and-loop straps rather than plastic tie wraps to eliminate the risk of cable damage during cycling
- Includes a low-profile fixed tray to both support and retain the CMA in its fully closed position
- Both the CMA and the tray mount without the use of tools through simple and intuitive snap-in designs

The CMA can be mounted to either side of the sliding rails without the use of tools or the need for conversion. For systems with one power supply unit (PSU), it is recommended to mount on the side opposite to that of the power supply to allow easier access to it and the rear drives (if applicable) for service or replacement.

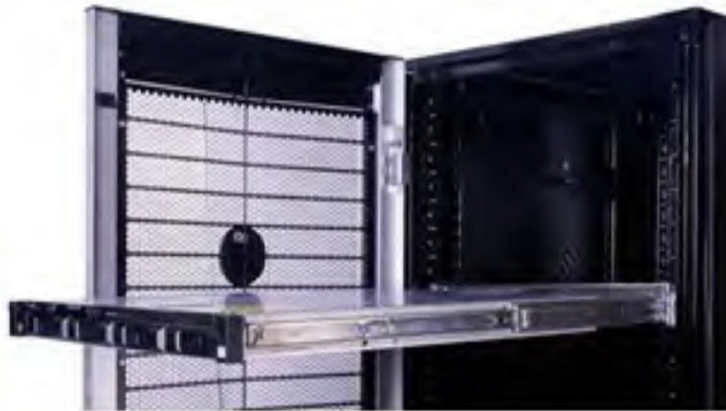
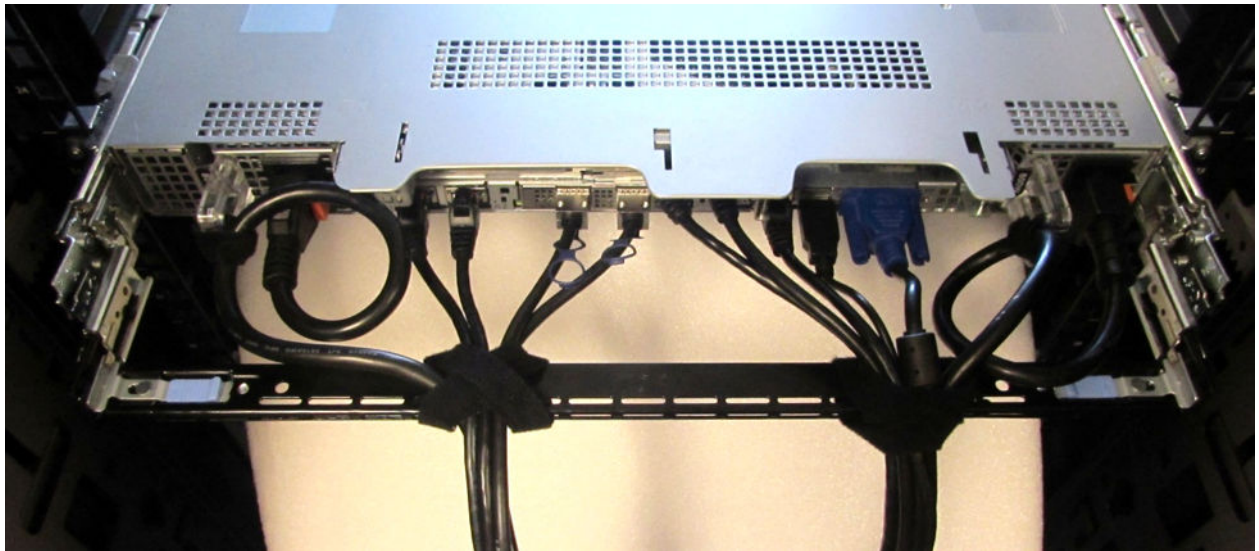


Figure 24. Cable Management Arm

## Strain Relief Bar

The optional strain relief bar (SRB) for the R660xs organizes and supports cable connections at the rear end of the server to avoid damage from bending.



**Figure 25. Cabled strain relief bar**

Sliding rails with optional SRB:

- Support tool-less attachment to rails
- Support two depth positions to accommodate various cable loads and rack depths
- Support cable loads and controls stress on server connectors
- Support cables can be segregated into discrete, purpose-specific bundles

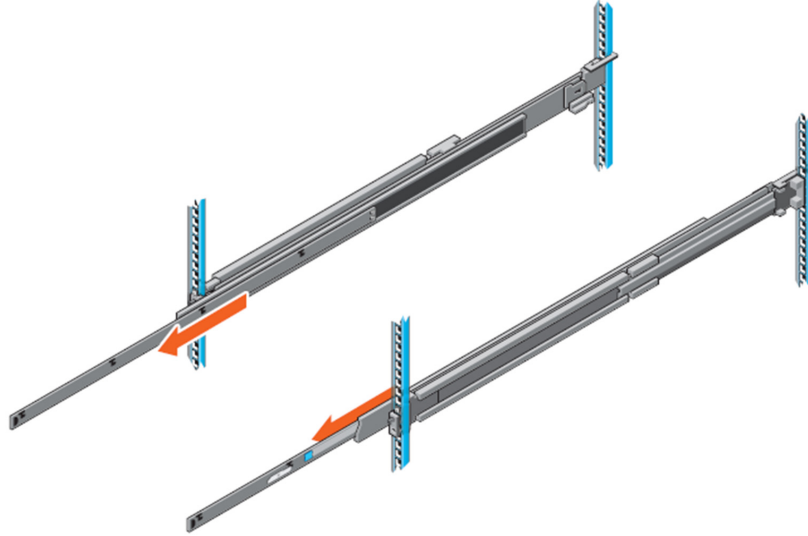
## Rack Installation

Drop-in design means that the system is installed vertically into the rails by inserting the standoffs on the sides of the system into the J-slots in the inner rail members with the rails in the fully extended position. The recommended method of installation is to first insert the rear standoffs on the system into the rear J-slots on the rails to free up a hand and then rotate the system down into the remaining J-slots while using the free hand to hold the rail against the side of the system.

Stab-in design means that the inner (chassis) rail members must first be attached to the sides of the system and then inserted into the outer (cabinet) members installed in the rack.

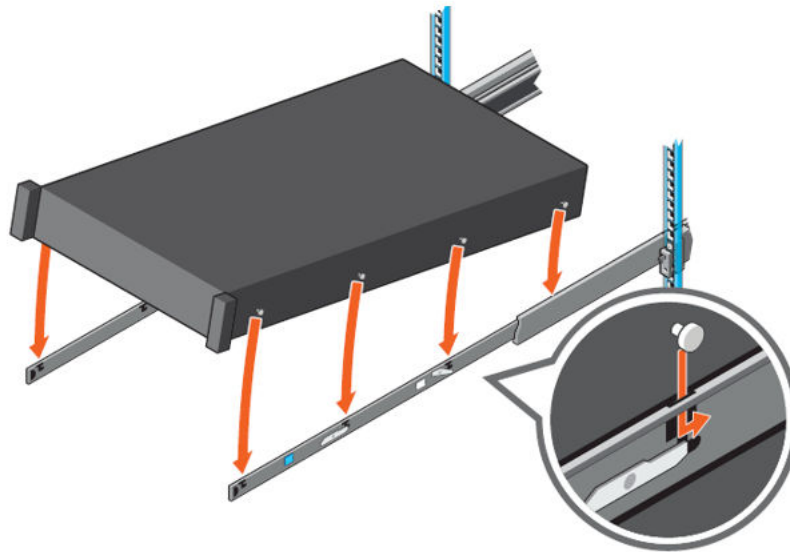
### Installing system into the rack (option A: Drop-In)

1. Pull the inner rails out of the rack until they lock into place.



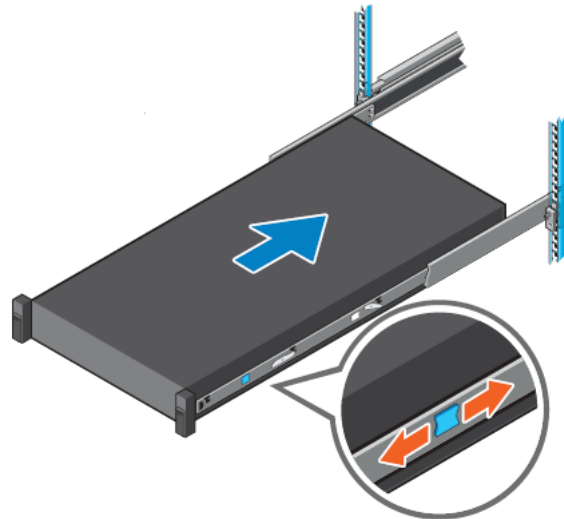
**Figure 26. Pull out inner rail**

2. Locate the rear rail standoff on each side of the system and lower them into the rear J-slots on the slide assemblies.
3. Rotate the system downward until all the rail standoffs are seated in the J-slots.



**Figure 27. Rail standoffs seated in J-slots**

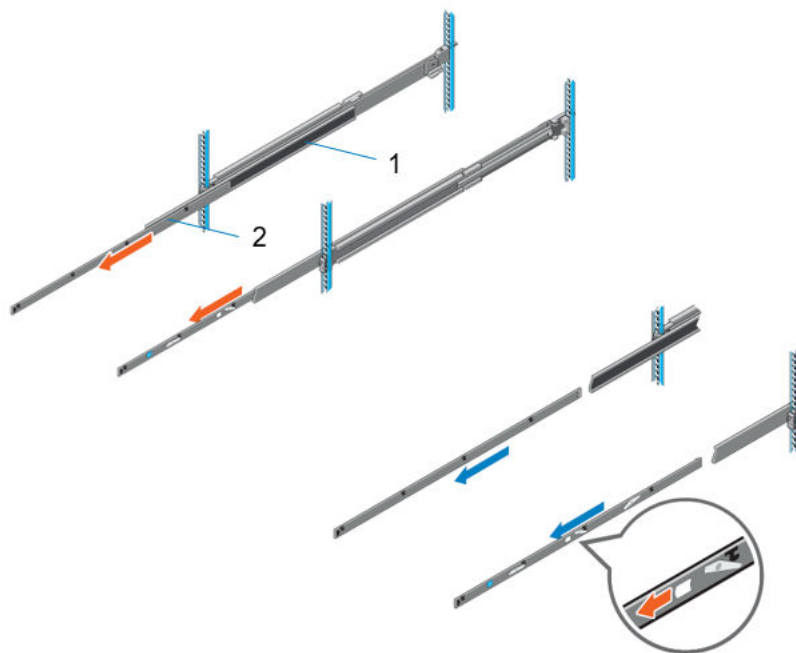
4. Push the system inward until the lock levers click into place.
5. Pull the blue side release lock tabs forward or backward on both rails and slide the system into the rack until the system is in the rack.



**Figure 28. Slide system into the rack**

## Installing the system into the rack (option B: Stab-In)

1. Pull the intermediate rails out of the rack until they lock into place.
2. Release the inner rail lock by pulling forward on the white tabs and sliding the inner rail out of the intermediate rails.

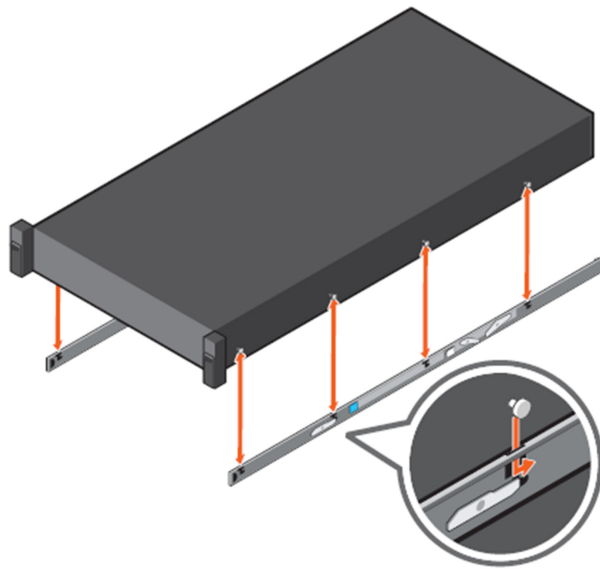


**Figure 29. Pull out the intermediate rail**

**Table 38. Rail component label**

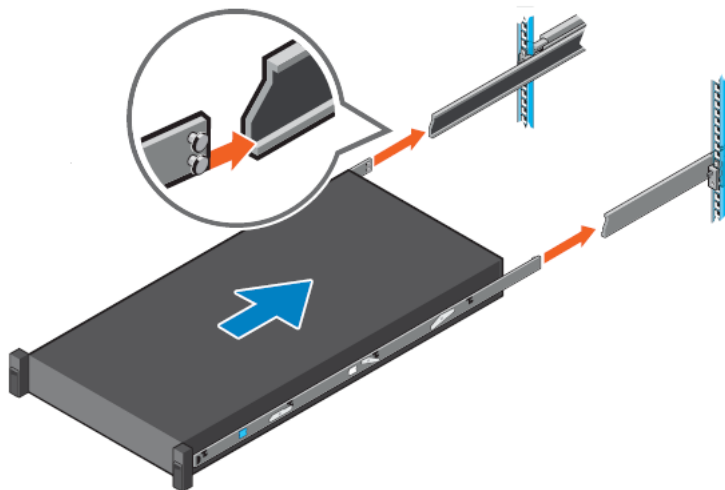
Number	Component
1	Intermediate rail
2	Inner rail

3. Attach the inner rails to the sides of the system by aligning the J-slots on the rail with the standoffs on the system and sliding forward on the system until they lock into place.



**Figure 30. Attach the inner rails to the system**

4. With the intermediate rails extended, install the system into the extended rails.



**Figure 31. Install system into the extended rails**

5. Pull blue slide release lock tabs forward or backward on both rails, and slide the system into the rack.

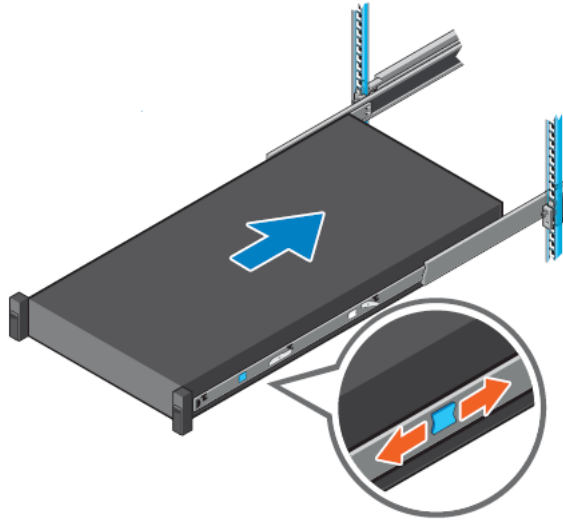


Figure 32. Slide system into the rack

# Supported operating systems

The PowerEdge R660xs system supports the following operating systems:

- Canonical Ubuntu Server LTS
- Microsoft Windows Server with Hyper-V
- Red Hat Enterprise Linux
- SUSE Linux Enterprise Server
- VMware vSAN/ESXi

For more information, go to [Operating System Manuals](#).



# Dell Systems Management

Dell delivers management solutions that help IT administrators effectively deploy, update, monitor, and manage IT assets. Dell solutions and tools enable you to quickly respond to problems by helping them to manage Dell servers efficiently; in physical, virtual, local, and remote environments; all without the need to install an agent in the operating system.

## Topics:

- [Integrated Dell Remote Access Controller \(iDRAC\)](#)
- [Systems Management software support matrix](#)

## Integrated Dell Remote Access Controller (iDRAC)

iDRAC9 delivers advanced, agent-free, local and remote server administration. Embedded in every PowerEdge server, iDRAC9 provides a secure means to automate a multitude of common management tasks. Because iDRAC is embedded within every PowerEdge server, there is no additional software to install; just plug in power and network cables, and iDRAC is ready to go. Even before installing an operating system (operating system) or hypervisor, IT administrators have a complete set of server management features at their fingertips.

With iDRAC9 in-place across the Dell PowerEdge portfolio, the same IT administration techniques and tools can be applied throughout. This consistent management platform allows easy scaling of PowerEdge servers as an organization's infrastructure grows. Customers can use the iDRAC RESTful API for the latest in scalable administration methods of PowerEdge servers. With this API, iDRAC enables support for the Redfish standard and enhances it with Dell extensions to optimize at-scale management of PowerEdge servers. By having iDRAC at the core, the entire OpenManage portfolio of Systems Management tools allows every customer to tailor an effective, affordable solution for any size environment.

Zero Touch Provisioning (ZTP) is embedded in iDRAC. ZTP - Zero Touch Provisioning is Intelligent Automation Dell's agent-free management puts IT administrators in control. Once a PowerEdge server is connected to power and networking, that system can be monitored and fully managed, whether you're standing in front of the server or remotely over a network. In fact, with no need for software agents, an IT administrator can: · Monitor · Manage · Update · Troubleshoot and remediate Dell servers With features like zero-touch deployment and provisioning, iDRAC Group Manager, and System Lockdown, iDRAC9 is purpose-built to make server administration quick and easy. For those customers whose existing management platform utilizes in-band management, Dell does provide iDRAC Service Module, a lightweight service that can interact with both iDRAC9 and the host operating system to support legacy management platforms.

When ordered with DHCP enabled from the factory, PowerEdge servers can be automatically configured when they are initially powered up and connected to your network. This process uses profile-based configurations that ensure each server is configured per your specifications. This feature requires an iDRAC Enterprise license.

iDRAC9 offers following license tiers:

**Table 39. iDRAC9 license tiers**

License	Description
iDRAC9 Basic	<ul style="list-style-type: none"> <li>• Available only on 100-500 series rack/tower</li> <li>• Basic instrumentation with iDRAC web UI</li> <li>• For cost conscious customers that see limited value in management</li> </ul>
iDRAC9 Express	<ul style="list-style-type: none"> <li>• Default on 600+ series rack/tower, modular, and XR series</li> <li>• Includes all features of Basic</li> <li>• Expanded remote management and server life-cycle features</li> </ul>
iDRAC9 Enterprise	<ul style="list-style-type: none"> <li>• Available as an upsell on all servers</li> <li>• Includes all features of Basic and Express. Includes key features such as virtual console, AD/LDAP support, and more</li> <li>• Remote presence features with advanced, Enterprise-class, management capabilities</li> </ul>

**Table 39. iDRAC9 license tiers (continued)**

License	Description
iDRAC9 Datacenter	<ul style="list-style-type: none"> <li>Available as an upsell on all servers</li> <li>Includes all features of Basic, Express, and Enterprise. Includes key features such as telemetry streaming, Thermal Manage, automated certificate management, and more</li> <li>Extended remote insight into server details, focused on high end server options, granular power, and thermal management</li> </ul>

For a full list of iDRAC features by license tier, see [Integrated Dell Remote Access Controller 9 User's Guide](#) at [Dell.com](#).

For more details on iDRAC9 including white papers and videos, see:

- [Support for Integrated Dell Remote Access Controller 9 \(iDRAC9\)](#) on the [Knowledge Base](#) page at [Dell.com](#)

## Systems Management software support matrix

**Table 40. Systems Management software support matrix**

Categories	Features	PE mainstream
Embedded Management and In-band Services	iDRAC9 (Express, Enterprise, and Datacenter licenses)	Supported
	OpenManage Mobile	Supported
	OM Server Administrator (OMSA)	Supported
	iDRAC Service Module (iSM)	Supported
	Driver Pack	Supported
Change Management	Update Tools (Repository Manager, DSU, Catalogs)	Supported
	Server Update Utility	Supported
	Lifecycle Controller Driver Pack	Supported
	Bootable ISO	Supported
Console and Plug-ins	OpenManage Enterprise	Supported
	Power Manager Plug-in	Supported
	Update Manager Plug-in	Supported
	SupportAssist Plug-in	Supported
	CloudIQ	Supported
Integrations and connections	OM Integration with VMware Vcenter/vROps	Supported
	OM Integration with Microsoft System Center (OMIMSC)	Supported
	Integrations with Microsoft System Center and Windows Admin Center (WAC)	Supported
	ServiceNow	Supported
	Ansible	Supported
	Third-party Connectors (Nagios, Tivoli, Microfocus)	Supported
Security	Secure Enterprise Key Management	Supported
	Secure Component Verification	Supported
Standard operating system	Red Hat Enterprise Linux, SUSE, Windows Server 2019 or 2022, Ubuntu, CentOS	Supported (Tier-1)

## Appendix A. Standards compliance

The system conforms to the following industry standards.

**Table 41. Industry standard documents**

Standard	URL for information and specifications
<b>ACPI</b> Advance Configuration and Power Interface Specification, v6.4	<a href="#">Uefi specifications and tools</a>
<b>Ethernet</b> IEEE Std 802.3-2022	<a href="#">ieee standards</a>
<b>MSFT WHQL</b> Microsoft Windows Hardware Quality Labs	<a href="https://microsoft.com/whdc/system/platform/pcdesign/desguide/serverdg.msp">microsoft.com/whdc/system/platform/pcdesign/desguide/serverdg.msp</a>
<b>IPMI</b> Intelligent Platform Management Interface, v2.0	<a href="https://intel.com/design/servers/ipmi">intel.com/design/servers/ipmi</a>
<b>DDR5 Memory</b> DDR5 SDRAM Specification	<a href="https://jedec.org/standards-documents/docs/jesd79-4.pdf">jedec.org/standards-documents/docs/jesd79-4.pdf</a>
<b>PCI Express</b> PCI Express Base Specification, v5.0	<a href="https://pcisig.com/specifications/pciexpress">pcisig.com/specifications/pciexpress</a>
<b>PMBus</b> Power System Management Protocol Specification, v1.2	<a href="#">pmbus specification and revisions</a>
<b>SAS</b> Serial Attached SCSI, 3 (SAS-3) (T10/INCITS 519)	<a href="#">SCSI storage interfaces information</a>
<b>SATA</b> Serial ATA Rev. 3.3	<a href="https://sata-io.org">sata-io.org</a> page
<b>SMBIOS</b> System Management BIOS Reference Specification, v3.3.0	<a href="#">BIOS reference specification page</a>
<b>TPM</b> Trusted Platform Module Specification, v1.2 and v2.0	<a href="https://trustedcomputinggroup.org">trustedcomputinggroup.org</a> page
<b>UEFI</b> Unified Extensible Firmware Interface Specification, v2.7	<a href="#">UEFIF specifications</a>
<b>PI</b> Platform Initialization Specification, v1.7	
<b>USB</b> Universal Serial Bus v2.0 and SuperSpeed v3.0 (USB 3.1 Gen1)	USB Implementers Forum, Inc. <a href="#">USB document library</a>
<b>NVMe</b> Express Base Specification. Revision 2.0c	<a href="#">NVME specifications</a>
<b>NVMe</b> Command Set Specifications	
1. NVMe Express NVM Command Set Specification. Revision 1.1c	
2. NVMe Express Zoned Namespaces Command Set. Revision 1.0c	
3. NVMe Express® Key Value Command Set. Revision 1.0c	
<b>NVMe</b> Transport Specifications	
1. NVMe Express over PCIe Transport. Revision 1.0c	
2. NVMe Express RDMA Transport Revision. 1.0b	
3. NVMe Express TCP Transport. Revision 1.0c	
<b>NVMe</b> NVMe Express Management Interface. Revision 1.2c	
<b>NVMe</b> NVMe Boot Specification. Revision 1.0	

## Appendix B: Additional specifications

### Topics:

- Chassis dimensions
- System weight
- Video specifications
- USB ports specifications
- PSU rating
- Environmental specifications

### Chassis dimensions

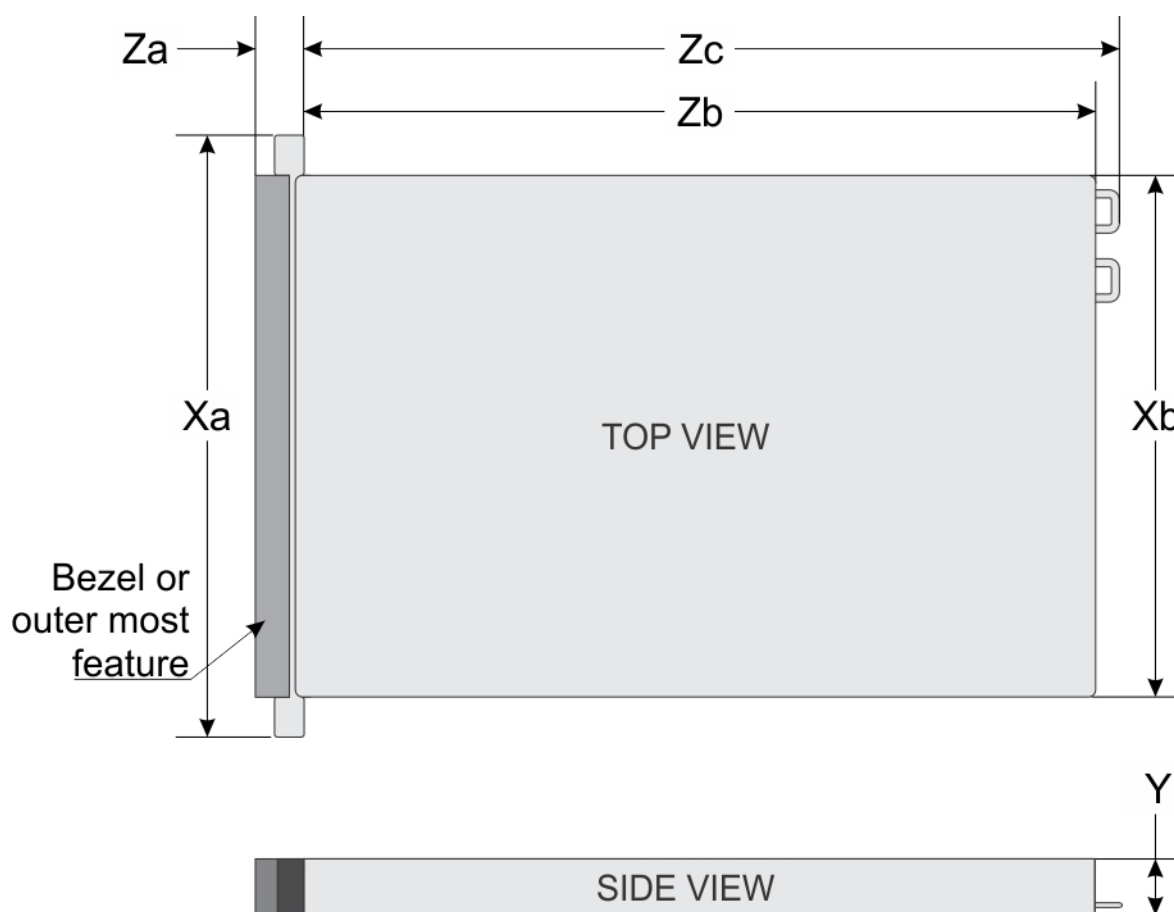


Figure 33. Chassis dimensions

Table 42. PowerEdge R660xs chassis dimensions

Drives	Xa	Xb	Y	Za	Zb	Zc
10 or 4 SATA/ SAS/NVMe drives	482 mm (18.976 inches)	434.0 mm (17.08 inches)	42.8 mm (1.685 inches)	35.84 mm (1.41 inches) With bezel	677.1 mm (26.65 inches) Ear to rear wall	712.95 mm (28.05 inches)

**Table 42. PowerEdge R660xs chassis dimensions (continued)**

Drives	Xa	Xb	Y	Za	Zb	Zc
8 NVMe drives				22 mm (0.86 inches) Without bezel		Ear to PSU handle without velcro strap
8 SATA/SAS drives or No backplane configuration	482 mm (18.976 inches)	434.0 mm (17.08 inches)	42.8 mm (1.685 inches)	35.84 mm (1.41 inches) With bezel 22 mm (0.86 inches) Without bezel	626.42 mm (24.66 inches) Ear to rear wall	661.37 mm (26.03 inches) Ear to PSU handle without velcro strap

**NOTE:** Zb is the nominal rear wall external surface where the system board I/O connectors reside.

## System weight

**Table 43. PowerEdge R660xs system weight**

System configuration	Maximum weight (with all drives/SSDs)
10 x 2.5-inch	18.74 kg (41.31 pound)
4 x 3.5-inch	19.45 Kg (55.33 pound)
8 x 2.5-inch	18.25 kg (40.23 pound)
No backplane configuration	15.38 kg (33.90 pound)

**Table 44. PowerEdge system weight handling recommendations**

Chassis weight	Description
40 pounds - 70 pounds	Recommend two person to lift
70 pounds- 120 pounds	Recommend three person to lift
≥ 121 pounds	Recommend to use a server-lift

## Video specifications

The PowerEdge R660xs system supports integrated Matrox G200 graphics controller with 16 MB of video frame buffer.

**Table 45. Supported video resolution options for the system**

Resolution	Refresh rate (Hz)	Color depth (bits)
1024 x 768	60	8, 16, 32
1280 x 800	60	8, 16, 32
1280 x 1024	60	8, 16, 32
1360 x 768	60	8, 16, 32
1440 x 900	60	8, 16, 32
1600 x 900	60	8, 16, 32
1600 x 1200	60	8, 16, 32
1680 x 1050	60	8, 16, 32
1920 x 1080	60	8, 16, 32

**Table 45. Supported video resolution options for the system (continued)**

Resolution	Refresh rate (Hz)	Color depth (bits)
1920 x 1200	60	8, 16, 32

## USB ports specifications

**Table 46. PowerEdge R660xs system USB ports specifications**

Front		Rear		Internal (Optional)	
USB port type	No. of ports	USB port type	No. of ports	USB port type	No. of ports
USB 2.0-compliant port	One	USB 2.0-compliant port	One	Internal USB 3.0-compliant port	One
iDRAC Direct port (Micro-AB USB 2.0-compliant port)	One	USB 3.0-compliant port	One		

- i NOTE:** The micro USB 2.0 compliant port can only be used as an iDRAC Direct or a management port.
- i NOTE:** The USB 2.0 specifications provide a 5 V supply on a single wire to power connected USB devices. A unit load is defined as 100 mA in USB 2.0, and 150 mA in USB 3.0. A device may draw a maximum of 5 unit loads (500 mA) from a port in USB 2.0; 6 (900 mA) in USB 3.0.
- i NOTE:** The USB 2.0 interface can provide power to low-power peripherals but must adhere to USB specification. An external power source is required for higher-power peripherals to function, such as external CD/DVD Drives.

## PSU rating

Below table lists the power capacity the PSUs in high/low line operation mode.

**Table 47. PSUs highline and lowline ratings**

—	600 W Titanium	700 W Titanium	800 W Platinum	1100 W Titanium	1100 W -48 VDC	1400 W Platinum	1800 W Titanium
Peak Power (Highline/-72 VDC)	600 W	1190 W	1360 W	1870 W	1870 W	2380 W	3060 W
Highline/-72 VDC	600 W	700 W	800 W	1100 W	1100 W	1400 W	1800 W
Peak Power (Lowline/-40 VDC)	600	N/A	1360 W	1785 W	N/A	1785 W	N/A
Lowline/-40 VDC	600	N/A	800 W	1050 W	N/A	1050 W	N/A
Highline 240 VDC	600 W	700 W	800 W	1100 W	N/A	1400 W	1800 W
DC-48-60 V	N/A	N/A	N/A	N/A	1100 W	N/A	N/A

The PowerEdge R660xs supports up to two AC power supplies with 1+1 redundancy, autosensing, and auto switching capability.

If two PSUs are present during POST, a comparison is made between the wattage capacities of the PSUs. In case the PSU wattages do not match, the larger of the two PSUs is enabled. Also, there is a PSU mismatch warning that is displayed in BIOS, iDRAC, or on the system LCD.

If a second PSU is added at run-time, in order for that particular PSU to be enabled, the wattage capacity of the first PSU must equal the second PSU. Otherwise, the PSU is flagged as unmatched in iDRAC and the second PSU is not enabled.

Dell PSUs have achieved Platinum efficiency levels as shown in the table below.

**Table 48. PSU efficiency level**

Efficiency Targets by Load						
Form factor	Output	Class	10%	20%	50%	100%
Redundant 60 mm	600 W AC	Platinum	89.00%	93.00%	94.00%	91.50%
	700 W AC	Titanium	90.00%	94.00%	96.00%	91.50%
	800 W AC	Platinum	89.00%	93.00%	94.00%	91.50%
	1100 W AC	Titanium	90.00%	94.00%	96.00%	91.50%
	1100 W -48 VDC	N/A	85.00%	90.00%	92.00%	90.00%
	1400 W AC	Platinum	89.00%	93.00%	94.00%	91.50%
	1800 W AC	Titanium	90.00%	94.00%	96.00%	94.00%

## Environmental specifications

**NOTE:** For additional information about environmental certifications, refer to the Product Environmental Datasheet located with the Documentation on [Dell Support](#).

**Table 49. Continuous Operation Specifications for ASHRAE A2**

Operational climatic range for category A2	Allowable continuous operations
Temperature range for altitudes <= 900 m (<= 2953 ft)	10–35°C (50–95°F) with no direct sunlight on the equipment
Humidity percent range (non-condensing at all times)	8% RH with -12°C (10.4°F) minimum dew point to 80% RH with 21°C (69.8°F) maximum dew point
Operational altitude de-rating	Maximum temperature is reduced by 1°C/300 m (1.8°F/984 Ft) above 900 m (2953 Ft)

**Table 50. Continuous Operation Specifications for ASHRAE A3**

Operational climatic range for category A3	Allowable continuous operations
Temperature range for altitudes <= 900 m (<= 2953 ft)	5–40°C (41–104°F) with no direct sunlight on the equipment
Humidity percent range (non-condensing at all times)	8% RH with -12°C (10.4°F) minimum dew point to 85% RH with 24°C (75.2°F) maximum dew point
Operational altitude de-rating	Maximum temperature is reduced by 1°C/175 m (1.8°F/574 Ft) above 900 m (2953 Ft)

**Table 51. Continuous Operation Specifications for ASHRAE A4**

Operational climatic range for category A4	Allowable continuous operations
Temperature range for altitudes <= 900 m (<= 2953 ft)	5–45°C (41–113°F) with no direct sunlight on the equipment
Humidity percent range (non-condensing at all times)	8% RH with -12°C (10.4°F) minimum dew point to 90% RH with 24°C (75.2°F) maximum dew point
Operational altitude de-rating	Maximum temperature is reduced by 1°C/125 m (1.8°F/410 Ft) above 900 m (2953 Ft)

**Table 52. Continuous Operation Specifications for Rugged Environment**

Operational climatic range for category A4	Allowable continuous operations
Temperature range for altitudes <= 900 m (<= 2953 ft)	5–45°C (41–113°F) with no direct sunlight on the equipment
Humidity percent range (non-condensing at all times)	8% RH with -12°C (10.4°F) minimum dew point to 90% RH with 24°C (75.2°F) maximum dew point
Operational altitude de-rating	Maximum temperature is reduced by 1°C/125 m (1.8°F/410 Ft) above 900 m (2953 Ft)

**Table 53. Common Environmental Specifications for ASHRAE A2, A3, A4 and Rugged**

Environmental Specifications for ASHRAE A2, A3, A4 and Rugged	Allowable continuous operations
Maximum temperature gradient (applies to both operation and non-operation)	20°C in an hour* (36°F in an hour) and 5°C in 15 minutes (9°F in 15 minutes), 5°C in an hour* (9°F in an hour) for tape <i>i</i> <b>NOTE:</b> * - Per ASHRAE thermal guidelines for tape hardware, these are not instantaneous rates of temperature change.
Non-operational temperature limits	-40 to 65°C (-104 to 149°F)
Non-operational humidity limits	5% to 95% RH with 27°C (80.6°F) maximum dew point
Maximum non-operational altitude	12,000 meters (39,370 feet)
Maximum operational altitude	3,048 meters (10,000 feet)

**Table 54. Maximum vibration specifications**

Maximum vibration	Specifications
Operating	0.21 G <sub>rms</sub> at 5 Hz to 500 Hz for 10 minutes (all operation orientations)
Storage	1.88 G <sub>rms</sub> at 10 Hz to 500 Hz for 15 minutes (all six sides tested)

**Table 55. Maximum shock pulse specifications**

Maximum shock pulse	Specifications
Operating	Six consecutively executed shock pulses in the positive and negative x, y, and z axis of 6 G for up to 11 ms.
Storage	Six consecutively executed shock pulses in the positive and negative x, y, and z axis (one pulse on each side of the system) of 71 G for up to 2 ms.

## Thermal restrictions

**Table 56. Thermal restriction matrix for processor and fans**

Configurati on / Processor TDP	No Backplane	4 x 3.5-inch SAS/SATA		8 x 2.5-inch SAS3/SATA	
Rear Storage	Rear 3 LP	Rear 3 LP	1 LP + 2 Rear drives	Rear 3 LP	Rear 1 LP + 2 Rear drives
125 W	STD fan STD HSK 45 °C	STD fan STD HSK 40 °C	STD fan STD HSK 35 °C	STD fan STD HSK 40 °C	HPR (Gold) fan STD HSK 35 °C
135 W	STD fan STD HSK	STD fan STD HSK	STD fan STD HSK	STD fan STD HSK	HPR (Gold) fan STD HSK



**Table 56. Thermal restriction matrix for processor and fans (continued)**

Configurati on / Processor TDP	No Backplane	4 x 3.5-inch SAS/SATA		8 x 2.5-inch SAS3/SATA	
	45 °C	40 °C	35 °C	40 °C	35 °C
150 W	STD fan STD HSK 40 °C	STD fan STD HSK 40 °C	STD fan STD HSK 35 °C	STD fan STD HSK 40 °C	HPR (Gold) fan STD HSK 35 °C
165 W	STD fan HPR HSK 40 °C	STD fan HPR HSK 35 °C	STD fan HPR HSK 35 °C	STD fan HPR HSK 35 °C	HPR (Gold) fan HPR HSK 35 °C
185 W	STD fan HPR HSK 40 °C	STD fan HPR HSK 35 °C	STD fan HPR HSK 35 °C	STD fan HPR HSK 35 °C	HPR (Gold) fan HPR HSK 35 °C
195 W	STD fan HPR HSK 35 °C	STD fan HPR HSK 35 °C	STD fan HPR HSK 35 °C	****HPR (Gold) fan HPR HSK 35 °C	HPR (Gold) fan HPR HSK 35 °C
205 W	STD fan HPR HSK 35 °C	STD fan HPR HSK 35 °C	STD fan HPR HSK 35 °C	STD fan HPR HSK 35 °C	HPR (Gold) fan HPR HSK 35 °C
225 W	STD fan HPR HSK 35 °C	*	*	HPR (Gold) fan HPR HSK 35 °C	HPR (Gold) fan HPR HSK 35 °C

**Table 57. Thermal restriction matrix for processor and fans**

Configur ation / Processo r TDP	10 x 2.5-inch SAS4/SATA		8 x 2.5-inch NVMe		10 x 2.5-inch NVMe	
Rear Storage	Rear 3 LP	1 LP + 2 Rear drives	Rear 3 LP	1 LP + 2 Rear drives	Rear 3 LP	1 LP + 2 Rear drives
125 W	HPR (Gold) fan STD HSK 40 °C	HPR (Gold) fan STD HSK 35 °C	HPR (Gold) fan STD HSK 40 °C	HPR (Gold) fan STD HSK 35 °C	HPR (Gold) fan STD HSK 40 °C	HPR (Gold) fan STD HSK 35 °C
135 W	HPR (Gold) fan STD HSK 40 °C	HPR (Gold) fan STD HSK 35 °C	HPR (Gold) fan STD HSK 40 °C	HPR (Gold) fan STD HSK 35 °C	HPR (Gold) fan STD HSK 40 °C	HPR (Gold) fan STD HSK 35 °C
150 W	HPR (Gold) fan STD HSK 40 °C	HPR (Gold) fan STD HSK 35 °C	HPR (Gold) fan STD HSK 40 °C	HPR (Gold) fan STD HSK 35 °C	HPR (Gold) fan STD HSK 40 °C	HPR (Gold) fan STD HSK 35 °C
165 W	HPR (Gold) fan HPR HSK	HPR (Gold) fan HPR HSK	HPR (Gold) fan HPR HSK	HPR (Gold) fan HPR HSK	HPR (Gold) fan HPR HSK	HPR (Gold) fan HPR HSK

**Table 57. Thermal restriction matrix for processor and fans (continued)**

Configur ation / Process or TDP	10 x 2.5-inch SAS4/SATA		8 x 2.5-inch NVMe		10 x 2.5-inch NVMe	
	35 °C	35 °C	35 °C	35 °C	35 °C	35 °C
185 W	HPR (Gold) fan HPR HSK 35 °C	HPR (Gold) fan HPR HSK 35 °C	HPR (Gold) fan HPR HSK 35 °C	HPR (Gold) fan HPR HSK 35 °C	HPR (Gold) fan HPR HSK 35 °C	HPR (Gold) fan HPR HSK 35 °C
195 W	HPR (Gold) fan HPR HSK 35 °C	HPR (Gold) fan HPR HSK 30 °C	HPR (Gold) fan HPR HSK 35 °C	HPR (Gold) fan HPR HSK 30 °C	HPR (Gold) fan HPR HSK 35 °C	HPR (Gold) fan HPR HSK 30 °C
205 W	HPR (Gold) fan HPR HSK 35 °C	HPR (Gold) fan HPR HSK 30 °C	HPR (Gold) fan HPR HSK 35 °C	HPR (Gold) fan HPR HSK 30 °C	HPR (Gold) fan HPR HSK 35 °C	HPR (Gold) fan HPR HSK 30 °C
225 W	HPR (Gold) fan HPR HSK 35 °C	HPR (Gold) fan HPR HSK 30 °C	HPR (Gold) fan HPR HSK 35 °C	HPR (Gold) fan HPR HSK 30 °C	HPR (Gold) fan HPR HSK 35 °C	HPR (Gold) fan HPR HSK 30 °C

**NOTE:**

- \*\* 5x fans is required for 1xProcessor without rear drive configuration.
- \*\*\* 7xfans is required for 2xProcessors configuration and 1xProcessor with rear drive configuration.
- \*\*\*\* Intel 6434/6526Y/6534 CPU would need HPR Gold Fan to support in this configuration.
- 4x3.5" SAS/SATA config only support DIMM up to 96G and all the other configs support DIMM up to 128G.

**Table 58. Thermal restriction matrix for processor and fans with TDP > 205 W, 225 W**

Front storage module Configurati on with Restriction s	No Backplane	2 x 3.5-inch SAS/SATA		4 x 2.5-inch SAS3/SATA	
Drives	No	HDD 0 ~ 1		HDD 0 ~ 3	
Rear Storage	Rear 3 LP	PCIe 1 + OCP only. PCIe 2, PCIe 3 and BOSS are not supported	1 LP + 2 Rear drives	Rear 3 LP	Rear 1 LP + 2 Rear drives
225 W	*	STD fan HPR HSK 35 °C	STD fan HPR HSK 30 °C	*	*
250 W	STD fan HPR HSK 35 °C	STD fan HPR HSK 35 °C	STD fan HPR HSK 30 °C	HPR (Gold) fan STD HSK 35 °C	HPR (Gold) fan STD HSK 35 °C

**Table 59. Thermal restriction matrix for processor and fans with TDP > 205 W, 225 W**

Front storage module Configuration with Restrictions	6 x 2.5-inch SAS4/SATA		4 x 2.5-inch NVMe		4 x 2.5-inch NVMe	
Drives	HDD 0 ~ 5		HDD 0 ~ 3		HDD 0 ~ 3	
Rear Storage	Rear 3 LP	1 LP + 2 Rear drives	Rear 3 LP	1 LP + 2 Rear drives	Rear 3 LP	1 LP + 2 Rear drives
225 W	*	*	*	*	*	*
250 W	HPR (Gold) fan HPR HSK 35 °C	HPR (Gold) fan HPR HSK 30 °C	HPR (Gold) fan HPR HSK 35 °C	HPR (Gold) fan HPR HSK 30 °C	HPR (Gold) fan HPR HSK 35 °C	HPR (Gold) fan HPR HSK 30 °C

**NOTE:**

- \* Configs supported in the "without HW restriction thermal restriction table"
- \*\* Except cold aisle configuration: 5 fans is required for 1 x Processor + without rear drive configuration
- \*\*\* Except cold aisle configuration: 7 fans is required for 2 x Processors configuration. and 1 x Processor + rear drive configuration
- 2 x3.5" SAS/SATA config only support DIMM up to 96GB and all the other configs support DIMM up to 128GB.

**Table 60. Label reference**

Label	Description
STD	Standard
LP	Low Profile
HPR (Gold)	High performance (gold grade)
HSK	Heat sink

**Thermal Restriction for ASHRAE A2/A3/A4**

**Table 61. No BP Configuration with iDRAC**

Dell PowerEdge Server Standard Operating Support (ASHRAE A2 compliant) All options supported unless otherwise noted.	Dell PowerEdge Server Extended Inletient 40° C Operating Support (ASHRAE A3 compliant)	Dell PowerEdge Server Extended Inletient 45° C Operating Support (ASHRAE A4 compliant)
<ul style="list-style-type: none"> <li>• STD Fan is required.</li> <li>• STD HSK is required for CPU Base TDP &lt;=150W</li> <li>• HPR HSK is required for CPU Base TDP &gt;150W</li> <li>• 2-processor all configs or 1-processor with Rear storage module config requires 7x fans</li> <li>• 1-processor without Rear storage module config requires 5x fans</li> <li>• 100G PCIe NIC could not support MFS1S00-VxxE (spec 75C) transceiver</li> </ul>	<ul style="list-style-type: none"> <li>• Not support CPU Base TDP &gt; 185W</li> <li>• STD Fan is required.</li> <li>• STD HSK is required for CPU Base TDP &lt;=150W</li> <li>• HPR HSK is required for CPU Base TDP &gt;150W.</li> <li>• Not support BOSS M.2 Module</li> <li>• Not support Non-Dell qualified peripheral cards and Channel devices (FW) cards</li> <li>• Not support NIC consuming power &gt;= 25W.</li> </ul>	<ul style="list-style-type: none"> <li>• Not support CPU Base TDP &gt; 135W</li> <li>• STD Fan and STD HSK is required.</li> <li>• Not support BOSS M.2 Module</li> <li>• Not support Non-Dell qualified peripheral cards and Channel devices (FW) cards</li> <li>• Not support NIC consuming power &gt;= 25W. Or PCIe cooling Tier&gt; 5</li> <li>• Not Support Config with Rear storage module</li> <li>• Not support OCP3.0 transfer rate &gt;25G or OCP3.0 cooling tier &gt; 6</li> </ul>

**Table 61. No BP Configuration with iDRAC**

<b>Dell PowerEdge Server Standard Operating Support (ASHRAE A2 compliant) All options supported unless otherwise noted.</b>	<b>Dell PowerEdge Server Extended Inletient 40° C Operating Support (ASHRAE A3 compliant)</b>	<b>Dell PowerEdge Server Extended Inletient 45° C Operating Support (ASHRAE A4 compliant)</b>
<ul style="list-style-type: none"> <li>● 100G OCP3.0 NIC could only support optic transceiver with thermal spec 85C and power &lt;=2.5W ( DPN:4WGYD)</li> <li>● 25G OCP3.0 NIC with 4 ports or PCIe cooling tier higher than or equal to 5 could only support optic transceiver with thermal spec 85C and power &lt;=1.2W ( DPN: M14MK)</li> <li>● 25G OCP3.0 NIC with PCIe cooling tier lower than 5 could not support spec 70C optic transceiver with power higher than 1.2W ( DPN: 0YR96)</li> <li>● H965e cannot be installed on PCIe slot 1</li> </ul>	<ul style="list-style-type: none"> <li>● Not Support Config with Rear storage module</li> <li>● Not support OCP transfer rate &gt;25G or cooling tier &gt; 9</li> <li>● Optic Transceiver with spec 85C is required</li> <li>● Two PSUs are required. System performance may be reduced in the event of a PSU failure</li> </ul>	<ul style="list-style-type: none"> <li>● Optic Transceiver with spec 85C is required.</li> <li>● Two PSUs are required. System performance may be reduced in the event of a PSU failure</li> </ul>

**Table 62. 4 x 3.5-inch SAS/SATA Configuration with iDRAC**

<b>Dell PowerEdge Server Standard Operating Support (ASHRAE A2 compliant) All options supported unless otherwise noted.</b>	<b>Dell PowerEdge Server Extended Inletient 40° C Operating Support (ASHRAE A3 compliant)</b>	<b>Dell PowerEdge Server Extended Inletient 45° C Operating Support (ASHRAE A4 compliant)</b>
<ul style="list-style-type: none"> <li>● STD Fan is required.</li> <li>● STD HSK is required for CPU Base TDP &lt;=150W</li> <li>● HPR HSK is required for CPU Base TDP &gt;150W</li> <li>● 2-processor all configs or 1-processor with Rear storage module config requires 7x fans</li> <li>● 1-processor without Rear storage module config requires 5x fans</li> <li>● HW restriction is required for CPU Base TDP &gt;205W <ul style="list-style-type: none"> <li>○ Front storage module only support 2x3.5 at HDD#0, HDD1 and HDD Blank F3F7V x 2 are required at HDD#2 and HDD#3</li> <li>○ RIO only support PCIe1 and OCP3.0. Could not support BOSS, PCIe2 and PCIe3.</li> <li>○ With Rear storage module config only support max. 30C ambient.</li> </ul> </li> <li>● Only support DDR5 DIMM up to 96 G.B</li> <li>● 100G PCIe NIC could not support MFS1S00-VxxE (spec 75C) transceiver.</li> <li>● 100G PCIe and OCP3.0 NIC could only support optic transceiver with thermal Spec 85C and power &lt;=2.5W</li> <li>● 25G PCIe NIC could only support optic transceiver with thermal Spec 85C and power &lt;=1.2W</li> </ul>	<ul style="list-style-type: none"> <li>● Not support CPU Base TDP &gt; 150W</li> <li>● STD Fan is required.</li> <li>● STD HSK is required</li> <li>● Not support BOSS M.2 Module</li> <li>● Not support Non-Dell qualified peripheral cards and Channel devices (FW) cards</li> <li>● Not support NIC consuming power &gt;= 25W.</li> <li>● Not Support Config with Rear storage module</li> <li>● Not support OCP transfer rate &gt;25G or cooling tier &gt; 10</li> <li>● Optic Transceiver with spec 85C is required</li> <li>● Two PSUs are required. System performance may be reduced in the event of a PSU failure</li> </ul>	<ul style="list-style-type: none"> <li>● Not support</li> </ul>

**Table 62. 4 x 3.5-inch SAS/SATA Configuration with iDRAC**

<b>Dell PowerEdge Server Standard Operating Support (ASHRAE A2 compliant) All options supported unless otherwise noted.</b>	<b>Dell PowerEdge Server Extended Inletient 40° C Operating Support (ASHRAE A3 compliant)</b>	<b>Dell PowerEdge Server Extended Inletient 45° C Operating Support (ASHRAE A4 compliant)</b>
<ul style="list-style-type: none"> <li>● 25G OCP3.0 NIC with 4 ports or PCIe cooling tier higher than 5 could only support optic transceiver with thermal spec 85C and power &lt;=1.2W</li> <li>● 25G OCP3.0 NIC with PCIe cooling tier lower than or equal to 5 could not support thermal spec 70C optic transceiver with power higher than 1.2W</li> <li>● The following SAS drives could NOT support in Rear storage module. (But could support in front SM)                             <ul style="list-style-type: none"> <li>○ Kioxia PM6 SAS all capacities</li> <li>○ SATA SSD, Hynix SE5031 all capacities or thermal spec &lt;70C</li> </ul> </li> <li>● H965e cannot be installed on PCIe slot 1</li> </ul>		

**Table 63. 8 x 2.5-inch SAS3/SATA Configuration with iDRAC**

<b>Dell PowerEdge Server Standard Operating Support (ASHRAE A2 compliant) All options supported unless otherwise noted.</b>	<b>Dell PowerEdge Server Extended Inletient 40° C Operating Support (ASHRAE A3 compliant)</b>	<b>Dell PowerEdge Server Extended Inletient 45° C Operating Support (ASHRAE A4 compliant)</b>
<ul style="list-style-type: none"> <li>● STD Fan is required for CPU Base TDP&lt;=205W</li> <li>● HPR Gold (VHP) Fan is required for CPU Base TDP&gt;205W and Intel 6434/ 6526Y/6534 CPU base TDP 195W.</li> <li>● STD HSK is required for CPU Base TDP &lt;=150W</li> <li>● HPR HSK is required for CPU Base TDP &gt;150W</li> <li>● 2-processor all configs or 1-processor with Rear storage module config requires 7x fans</li> <li>● 1-processor without Rear storage module config requires 5x fans</li> <li>● HW restriction is required for CPU Base TDP &gt;225W                             <ul style="list-style-type: none"> <li>○ Front storage moduleonly support 4x2.5"SAS/SATA drives at HDD#0~3, and HDD Bracket GG6M3 x1 and M8KTX x1 are required at empty HDD bay</li> </ul> </li> <li>● 100G PCIe and OCP3.0 NIC could only support optic transceiver with thermal Spec 85C and power &lt;=2.5W</li> <li>● 25G PCIe NIC could only support optic transceiver with thermal Spec 85C and power &lt;=1.2W</li> <li>● 25G OCP3.0 NIC with 4 ports or PCIe cooling tier higher than 5 could</li> </ul>	<ul style="list-style-type: none"> <li>● Not support CPU Base TDP &gt; 150W</li> <li>● STD Fan is required.</li> <li>● STD HSK is required</li> <li>● Not support BOSS M.2 Module</li> <li>● Not support Non-Dell qualified peripheral cards and Channel devices (FW) cards</li> <li>● Not support NIC consuming power &gt;= 25W.</li> <li>● Not Support Config with Rear storage module</li> <li>● Not support OCP transfer rate &gt;25G or cooling tier &gt; 10</li> <li>● Optic Transceiver with spec 85C is required</li> <li>● Two PSUs are required. System performance may be reduced in the event of a PSU failure</li> </ul>	<ul style="list-style-type: none"> <li>● Not support</li> </ul>

**Table 63. 8 x 2.5-inch SAS3/SATA Configuration with iDRAC**

<b>Dell PowerEdge Server Standard Operating Support (ASHRAE A2 compliant) All options supported unless otherwise noted.</b>	<b>Dell PowerEdge Server Extended Inletient 40° C Operating Support (ASHRAE A3 compliant)</b>	<b>Dell PowerEdge Server Extended Inletient 45° C Operating Support (ASHRAE A4 compliant)</b>
<p>only support optic transceiver with thermal spec 85C and power &lt;=1.2W</p> <ul style="list-style-type: none"> <li>● 25G OCP3.0 NIC with PCIe cooling tier lower than or equal to 5 could not support thermal spec 70C optic transceiver with power higher than 1.2W</li> <li>● The following SAS drives could NOT support in Rear storage module. (But could support in front storage)                             <ul style="list-style-type: none"> <li>○ Kioxia PM6 SAS all capacities</li> <li>○ SATA SSD, Hynix SE5031 all capacities or thermal spec &lt;70C</li> </ul> </li> <li>● H965e cannot be installed on PCIe slot 1</li> </ul>		

**Table 64. 10 x 2.5-inch SAS4/SATA Configuration with iDRAC**

<b>Dell PowerEdge Server Standard Operating Support (ASHRAE A2 compliant) All options supported unless otherwise noted.</b>	<b>Dell PowerEdge Server Extended Inletient 40° C Operating Support (ASHRAE A3 compliant)</b>	<b>Dell PowerEdge Server Extended Inletient 45° C Operating Support (ASHRAE A4 compliant)</b>
<ul style="list-style-type: none"> <li>● HPR Gold (VHP) Fan is required for all configurations</li> <li>● STD HSK is required for CPU Base TDP &lt;=150W</li> <li>● HPR HSK is required for CPU Base TDP &gt;150W</li> <li>● 2-processor all configs or 1-processor with Rear storage module config requires 7x fans</li> <li>● 1-processor without Rear storage module config requires 5x fans</li> <li>● HW restriction is required for CPU Base TDP &gt;225W                             <ul style="list-style-type: none"> <li>○ Front storage module only support 6x2.5"SAS/SATA drives at HDD#0~5, and HDD Bracket GG6M3 x2 are required at empty HDD bay.</li> </ul> </li> <li>● 100G PCIe and OCP3.0 NIC could only support optic transceiver with thermal Spec 85C and power &lt;=2.5W</li> <li>● 25G PCIe NIC could not support thermal spec 70C optic transceiver with power higher than 1.2W</li> <li>● 25G OCP3.0 NIC with 4 ports or PCIe cooling tier higher 5 could only support optic transceiver with thermal spec 85C and power &lt;=1.2W</li> <li>● 25G OCP3.0 NIC with PCIe cooling tier lower than or equal to 5 could not support thermal spec 70C optic transceiver with power higher than 1.2W</li> </ul>	<ul style="list-style-type: none"> <li>● Not support CPU Base TDP &gt; 150W</li> <li>● .</li> <li>● HPR Gold (VHP) Fan is required.</li> <li>● STD HSK is required</li> <li>● Not support BOSS M.2 Module</li> <li>● Not support Non-Dell qualified peripheral cards and Channel devices (FW) cards</li> <li>● Not support NIC consuming power &gt;= 25W.</li> <li>● Not Support Config with Rear storage module</li> <li>● Not support OCP transfer rate &gt;25G or cooling tier &gt; 10</li> <li>● Optic Transceiver with spec 85C is required</li> <li>● Two PSUs are required. System performance may be reduced in the event of a PSU failure</li> </ul>	<ul style="list-style-type: none"> <li>● Not support</li> </ul>

**Table 64. 10 x 2.5-inch SAS4/SATA Configuration with iDRAC**

<b>Dell PowerEdge Server Standard Operating Support (ASHRAE A2 compliant) All options supported unless otherwise noted.</b>	<b>Dell PowerEdge Server Extended Inletient 40° C Operating Support (ASHRAE A3 compliant)</b>	<b>Dell PowerEdge Server Extended Inletient 45° C Operating Support (ASHRAE A4 compliant)</b>
<ul style="list-style-type: none"> <li>• With Rear storage module config only support max. 30C ambient when CPU Base TDP&gt;=205W</li> <li>• The following SAS drives could NOT support in Rear storage module. (But could support in front storage)                             <ul style="list-style-type: none"> <li>○ Kioxia PM6 SAS all capacities</li> <li>○ SATA SSD, Hynix SE5031 all capacities or thermal spec &lt;70C</li> </ul> </li> </ul>		

**Table 65. 8 x 2.5-inch NVMe configuration with iDRAC**

<b>Dell PowerEdge Server Standard Operating Support (ASHRAE A2 compliant) All options supported unless otherwise noted.</b>	<b>Dell PowerEdge Server Extended Inletient 40° C Operating Support (ASHRAE A3 compliant)</b>	<b>Dell PowerEdge Server Extended Inletient 45° C Operating Support (ASHRAE A4 compliant)</b>
<ul style="list-style-type: none"> <li>• HPR Gold (VHP) Fan is required for all configurations</li> <li>• STD HSK is required for CPU Base TDP &lt;=150W</li> <li>• HPR HSK is required for CPU Base TDP &gt;150W</li> <li>• 2-processor all configs or 1-processor with Rear storage module config requires 7x fans</li> <li>• 1-processor without Rear storage module config requires 5x fans</li> <li>• HW restriction is required for CPU Base TDP &gt;225W                             <ul style="list-style-type: none"> <li>○ Front storage module only support 4x2.5"NVMe at HDD#0~3, and HDD Bracket GG6M3 x3 are required at empty HDD bay.</li> </ul> </li> <li>• 100G PCIe and OCP3.0 NIC could only support optic transceiver with thermal spec 85C and power &lt;=2.5W</li> <li>• 25G OCP3.0 NIC with 4 ports or PCIe cooling tier higher 5 could only support optic transceiver with thermal spec 85C and power &lt;=1.2W</li> <li>• 25G OCP3.0 NIC with PCIe cooling tier lower than or equal to 5 could not support thermal spec 70C optic transceiver with power higher than 1.2W</li> <li>• With Rear storage module config only support max. 30C ambient when CPU Base TDP&gt;=205W</li> <li>• The following NVMe drives could NOT support in Rear storage module. (But could support in front storage)                             <ul style="list-style-type: none"> <li>○ Samsung PM1735a/PM1735 Capacities &gt; 6.4TB</li> <li>○ Samsung PM1733a/PM1733 Capacities &gt; 7.68TB</li> </ul> </li> </ul>	<ul style="list-style-type: none"> <li>• Not support CPU Base TDP &gt; 150W</li> <li>• HPR Gold (VHP) Fan is required.</li> <li>• STD HSK is required</li> <li>• Not support BOSS M.2 Module</li> <li>• Not support Non-Dell qualified peripheral cards and Channel devices (FW) cards</li> <li>• Not support NIC consuming power &gt;= 25W.</li> <li>• Not Support Config with Rear storage module</li> <li>• Not support OCP transfer rate &gt;25G or cooling tier &gt; 10</li> <li>• Optic Transceiver with spec 85C is required</li> <li>• Two PSUs are required. System performance may be reduced in the event of a PSU failure</li> </ul>	<ul style="list-style-type: none"> <li>• Not support</li> </ul>

**Table 65. 8 x 2.5-inch NVMe configuration with iDRAC**

<b>Dell PowerEdge Server Standard Operating Support (ASHRAE A2 compliant) All options supported unless otherwise noted.</b>	<b>Dell PowerEdge Server Extended Inletient 40° C Operating Support (ASHRAE A3 compliant)</b>	<b>Dell PowerEdge Server Extended Inletient 45° C Operating Support (ASHRAE A4 compliant)</b>
<ul style="list-style-type: none"> <li>○ Skhynix PE8010 capacity &gt; 960 GB</li> <li>○ Kioxia CM6 all capacities</li> <li>○ Redtail NVMe all capacities</li> <li>○ Skhynix PE8110 capacity &gt; 960 GB</li> </ul>		

**Table 66. 10 x 2.5-inch NVMe configuration with iDRAC**

<b>Dell PowerEdge Server Standard Operating Support (ASHRAE A2 compliant) All options supported unless otherwise noted.</b>	<b>Dell PowerEdge Server Extended Inletient 40° C Operating Support (ASHRAE A3 compliant)</b>	<b>Dell PowerEdge Server Extended Inletient 45° C Operating Support (ASHRAE A4 compliant)</b>
<ul style="list-style-type: none"> <li>● HPR Gold (VHP) Fan is required for all configurations</li> <li>● STD HSK is required for CPU Base TDP &lt;=150W</li> <li>● HPR HSK is required for CPU Base TDP &gt;150W</li> <li>● 2-processor all configs or 1-processor with Rear storage module config requires 7x fans</li> <li>● 1-processor without Rear storage module config requires 5x fans</li> <li>● HW restriction is required for CPU Base TDP &gt;225W <ul style="list-style-type: none"> <li>○ Front storage module only support 4x2.5"NVMe at HDD#0~3, and HDD Bracket GG6M3 x3 are required at empty HDD bay. .</li> </ul> </li> <li>● 100G PCIe NIC could not support MFS1S00-VxxE (spec 75C) transceiver but could support optic transceiver with thermal spec 70C and 85C.</li> <li>● 100G PCIe and OCP3.0 NIC could only support optic transceiver with thermal spec 85C and power &lt;=2.5W</li> <li>● 25G OCP3.0 NIC with 4 ports or PCIe cooling tier higher 5 could only support optic transceiver with thermal spec 85C and power &lt;=1.2W</li> <li>● 25G OCP3.0 NIC with PCIe cooling tier lower than or equal to 5 could not support thermal spec 70C optic transceiver with power higher than 1.2W</li> <li>● With Rear storage module config only support max. 30C ambient when CPU Base TDP&gt;=205W</li> <li>● The following NVMe drives could NOT support in Rear storage module. (But could support in front storage) <ul style="list-style-type: none"> <li>○ Samsung PM1735a/PM1735 Capacities &gt; 6.4TB</li> </ul> </li> </ul>	<ul style="list-style-type: none"> <li>● Not support CPU Base TDP &gt; 150W</li> <li>● HPR Gold (VHP) Fan is required.</li> <li>● STD HSK is required</li> <li>● Not support BOSS M.2 Module</li> <li>● Not support Non-Dell qualified peripheral cards and Channel devices (FW) cards</li> <li>● Not support NIC consuming power &gt;= 25W.</li> <li>● Not Support Config with Rear storage module</li> <li>● Not support OCP transfer rate &gt;25G or cooling tier &gt; 10</li> <li>● Optic Transceiver with spec 85C is required</li> <li>● Two PSUs are required. System performance may be reduced in the event of a PSU failure</li> </ul>	<ul style="list-style-type: none"> <li>● Not support</li> </ul>



**Table 66. 10 x 2.5-inch NVMe configuration with iDRAC**

Dell PowerEdge Server Standard Operating Support (ASHRAE A2 compliant) All options supported unless otherwise noted.	Dell PowerEdge Server Extended Inletient 40° C Operating Support (ASHRAE A3 compliant)	Dell PowerEdge Server Extended Inletient 45° C Operating Support (ASHRAE A4 compliant)
<ul style="list-style-type: none"> <li>o Samsung PM1733a/PM1733 Capacities &gt; 7.68TB</li> <li>o Skhynix PE8010 Capacity &gt; 960 GB</li> <li>o Kioxia CM6 all capacities</li> <li>o Redtail NVMe all capacities</li> <li>o Skhynix PE8110 capacity &gt; 960 GB</li> </ul>		

**Table 67. Thermal Solution Configuration**

Configurations	Rear drive configurations	Processor (TDP)	Fan type	Heat sink type	Air Shroud	Memory Blank	Processor Blank	Fan Counts	Fan Blank
4 x 3.5-inch drives	without rear drives	TDP <= 150 W	STD fan	STD HSK	Yes	No	Only required on processor 2 for 1 processor Configuration	7 x fans for 2 processors and 1xProcessor + Rear HDD Configuration	Only required on fan Slot 1 and slot 2 for 5x Fans configuration
		150 W < TDP <= 205 W	STD fan	HPR HSK					
	with rear dries	TDP <= 150 W	STD fan	STD HSK		Yes			
		150 W < TDP <= 205 W		HPR HSK					
8 x 2.5-inch SAS/SATA drives	without rear drives	TDP <= 150 W	STD fan	STD HSK	No	No	Configuration + W/O Rear HDDs Config	5 x fans for 1 processor	
		150 W < TDP <= 205 W	**STD fan	HPR HSK					
		205 W < TDP <= 225 W	HPR Gold Fan (VHP)	HPR HSK					
8 x 2.5-inch SAS/SATA drives	with rear dries	TDP <= 150 W	HPR Gold Fan (VHP)	STD HSK	Yes	Yes			
		150 W < TDP <= 225 W		HPR HSK					
10 x 2.5-inch SAS4/SATA drives	without rear drives	TDP <= 150 W	HPR Gold Fan (VHP)	STD HSK	No	No			
		150 W < TDP <= 225 W		HPR HSK					
	with rear dries	TDP <= 150 W	HPR Gold Fan (VHP)	STD HSK					Yes
		150 W < TDP <= 225 W		HPR HSK					
8 and 10 x 2.5-inch drives	without rear drives	TDP <= 150 W	HPR Gold Fan (VHP)	STD HSK	Yes	Yes			

**Table 67. Thermal Solution Configuration (continued)**

Configurations	Rear drive configurations	Processor (TDP)	Fan type	Heat sink type	Air Shroud	Memory Blank	Processor Blank	Fan Counts	Fan Blank
NVMe drives		150 W < TDP <= 225 W		HPR HSK					
8 and 10 x 2.5-inch NVMe drives	with rear drives	TDP <= 150 W	HPR Gold Fan (VHP)	STD HSK		Yes			
		150 W < TDP <= 225 W		HPR HSK					
No Backplane	without rear drives	TDP <= 150 W	STD fan	STD HSK		No			
		150 W < TDP <= 250 W		HPR HSK					

## Appendix C Additional resources

**Table 68. Additional resources**

Resource	Description of contents	Location
Installation and Service Manual	<p>This manual, available in PDF format, provides the following information:</p> <ul style="list-style-type: none"> <li>• Chassis features</li> <li>• System Setup program</li> <li>• System indicator codes</li> <li>• System BIOS</li> <li>• Remove and replace procedures</li> <li>• Diagnostics</li> <li>• Jumpers and connectors</li> </ul>	<a href="https://Dell.com/Support/Manuals">Dell.com/Support/Manuals</a>
Getting Started Guide	<p>This guide ships with the system, and is also available in PDF format. This guide provides the following information:</p> <ul style="list-style-type: none"> <li>• Initial setup steps</li> </ul>	<a href="https://Dell.com/Support/Manuals">Dell.com/Support/Manuals</a>
Rack Installation Guide	This document ships with the rack kits, and provides instructions for installing a server in a rack.	<a href="https://Dell.com/Support/Manuals">Dell.com/Support/Manuals</a>
System Information Label	The system information label documents the system board layout and system jumper settings. Text is minimized due to space limitations and translation considerations. The label size is standardized across platforms.	Inside the system chassis cover
QR code for system resources	This code on the chassis can be scanned by a phone application to access additional information and resources for the server, including videos, reference materials, service tag information, and Dell contact information.	Inside the system chassis cover
Enterprise Infrastructure Planning Tool (EIPT)	The Dell online EIPT enables easier and more meaningful estimates to help you determine the most efficient configuration possible. Use EIPT to calculate the power consumption of your hardware, power infrastructure, and storage.	<a href="https://Dell.com/calc">Dell.com/calc</a>

### Topics:

- [Documentation](#)
- [Customer kits](#)

# Documentation

This section provides information about the documentation resources for your system.

**Table 69. Documentation resources**

Document	Location
Factory Configuration Matrix	<a href="#">Sales Portal</a>
SPM (Slot Priority Matrix)	<a href="#">Sales Portal</a>
NDA Deck	<a href="#">Sales Portal</a>
Installation and Service Manual (ISM)	<a href="#">PowerEdge Manuals</a>
Field Service Manual (FSM)	<a href="#">PowerEdge Manuals</a> > <a href="#">Sing in</a>
Technical Guide	<a href="#">Dell Support</a> page > <b>Products</b> > <b>IT infrastructure</b> > <b>Products</b>
Spec Sheet	<a href="#">Dell Support</a> page > <b>Products</b> > <b>IT infrastructure</b> > <b>Products</b>

## Customer kits


### Dell Upgrades

It is not always possible to plan for new applications, future workloads, and business needs. Unleash the full power of your Dell Technologies Infrastructure. When budget does not permit the purchase of new servers, Dell Upgrades is a cost-effective method to repurpose and unleash the full power of existing server, storage, and networking infrastructure.




- Protect your mission-critical operations by using only genuine Dell OEM-validated Upgrades and the technical expertise of Dell ProSupport
- Flex and scale existing infrastructure by upgrading, adding memory or storage drives to cost-effectively and quickly meet new workloads and demands
- Dell Upgrades are the same peripheral commodities that your customer may improve or maintain their server after the initial point of sale

### Upgrades portfolio


**Table 70. Upgrade category**

Dell Upgrade Category	Sample Picture	Dell Upgrade Category Offerings
<p>Memory</p> <p>Memory upgrades are essential for keeping your customers operating at peak performance as their business needs grow and their workloads increase. We tend to see strong demand for server memory because it is the easiest and most cost-effective way to improve system performance.</p>		<p>DDR5 5600 MT/s and 4800 MT/s</p>

**Table 70. Upgrade category (continued)**

Dell Upgrade Category	Sample Picture	Dell Upgrade Category Offerings
<p>Storage</p> <p>Dell offers both solid-state drive and hard disk drive storage options for enterprise systems with SATA, SAS or NVMe interfaces. SSDs excel in speed, high-performance I/O requirements, and high reliability due to the lack of spinning disks. Hard Disk Drives (HDDs) store data on spinning disks and offer value for the amount of data storage for the price.</p> <p>Dell offers both solid-state drive and hard disk drive storage options for enterprise systems with SATA, SAS interfaces. SSDs excel in speed, high-performance I/O requirements, and high reliability due to the lack of spinning disks. Hard Disk Drives (HDDs) store data on spinning disks and offer value for the amount of data storage for the price.</p>		<p>HDD: SATA, SAS interface</p> <p>SSD: SATA, SAS, PCI</p> <p>NVMe interface Tape Drive or Media</p>
<p>Processor</p> <p>Processor upgrades help customers perform and accomplish more tasks overall, saving them valuable time. Our processor upgrades include Intel® Xeon® Scalable processors to meet your customers workload needs with increased cores and improved security.</p>		<p>Processors (Intel)</p> <p>Heat sinks</p>
<p>Networking and Optics</p> <p>Our networking and optics components—network interface cards, transceivers, optical cables, and more—are key in today’s data center environment, helping customers to improve bandwidth to better manage increase in workloads, devices, users, and interconnected systems.</p>		<p>Network cards</p> <p>Transceivers (Optics)</p>

**Table 70. Upgrade category (continued)**

Dell Upgrade Category	Sample Picture	Dell Upgrade Category Offerings
<p>Accessories: Dell sells accessories like power supplies, cables and power cables, bezels, controller cards, GPU, PERC and other components to complete the Dell Upgrades portfolio and redundancies.</p>		<ul style="list-style-type: none"> <li>Controller cards</li> <li>Power supplies</li> <li>Cables</li> <li>Rail kits</li> <li>Bezels</li> <li>Power cords</li> <li>GPU</li> <li>PERC</li> <li>BOSS</li> <li>Power cords</li> <li>Cable Management Arm (CAM)</li> <li>Fans</li> <li>Serial board</li> <li>Internal USB</li> </ul>

## Upgrades reference links

- [Main Upgrades Page](#)
- [Customer Kit Selector](#)
- [Dell Parts Finder Tool](#) (Customer Facing Tool)

# Appendix D: Service and support

## Topics:

- [Default support levels](#)
- [Other services and support information](#)

## Default support levels

This system offers 3 years Dell ProSupport Next Business Day (NBD), including 24x7 phone support and NBD parts and labor support.

## Default deployment levels

This system is defaulted to the ProDeploy Dell Server which includes onsite hardware installation and remote software configuration. Optionally, the customer may choose to any of the factory or field deployment offers listed below.

## Other services and support information

Dell Technologies Services include a wide, customizable range of service options to simplify the assessment, design, implementation, management and maintenance of IT environments and to help transition from platform to platform.

Depending on the current business requirements and correct level of service for customers, we provide factory, onsite, remote, modular, and specialized services that fit the customer requirements and budget. We will help with a little or a lot, based on the customers choice, and provide access to our global resources.

## Dell deployment services

### [Dell ProDeploy Infrastructure Suite](#)

ProDeploy Infrastructure Suite provides a variety of deployment offerings that satisfy a customer's unique needs. It is made up of 5 offers: ProDeploy Configuration Services, ProDeploy Rack Integration Services, Basic Deployment, ProDeploy, and ProDeploy Plus.

# ProDeploy Infrastructure Suite for servers

Versatile choices for accelerated deployments

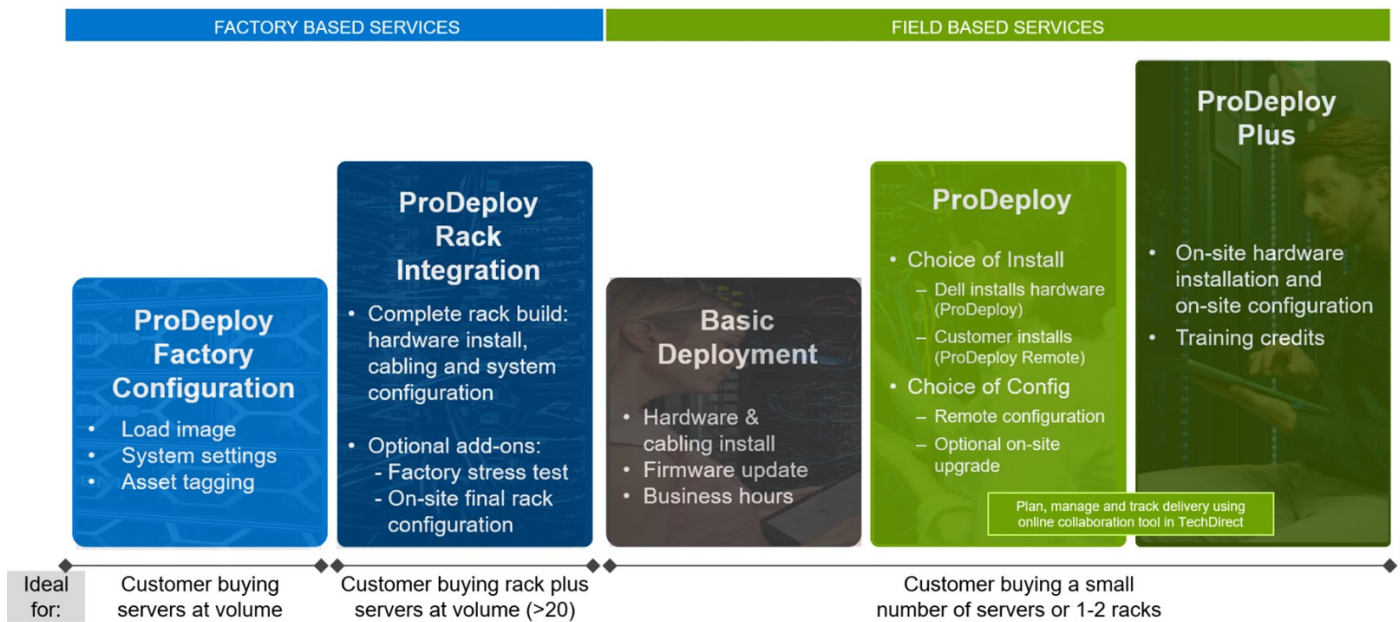


Figure 34. ProDeploy Infrastructure Suite for servers

The new Factory Services consist of two tiers of deployment that happen prior to shipping to the customer's site.

### Factory Based Services:

- ProDeploy Factory Configuration - Ideal for customers buying servers in volume and seeking pre-configuration prior to shipping such as: custom image, system settings, and asset tagging so it arrives ready to use out of the box. Furthermore, servers can be packaged and bundled to meet specific shipping and distribution requirements for each customer location to facilitate the rollout process. Upsell one of the field based services (below) if a customer needs assistance with the final server installation.
- ProDeploy Rack Integration - Ideal for customers seeking to build out fully integrated racks prior to shipping. These rack builds include hardware install, cabling, and full system configuration. You can also add-on a factory stress test and optional on-site final rack configuration to complete the rack installation.
  - STANDARD SKUs for Rack Integration is available in US only and requires:
    - 20 or more devices (R and C series servers and all Dell or non-Dell switches). Use Informational SKUs for Dell switches or 3rd party products
    - Shipping to contiguous US
  - USE CUSTOM QUOTE for Rack Integration for:
    - All countries except USA
    - Racks containing less than 20 servers
    - Any rack that includes VxRail or Storage
    - Shipping outside contiguous US
    - Shipping to multiple locations

### Field Based Services:

- Basic Deployment consists of the hardware installation, cabling and firmware update during normal standard business hours. Basic Deployment is traditionally sold to Competency Enabled Partners. Competency enabled partners often have Dell do the hardware installation while they complete the software configuration.
- ProDeploy consists of your hardware installation and configuration of the software using offshore resources. ProDeploy is great for customers who are price sensitive or who are remote from their data centers and don't require an onsite presence.
- ProDeploy Plus will give you in-region or onsite resources to complete the engagement for the customer. It also comes with additional features such as Post Deployment Configuration Assistance and Training Credits.



# ProDeploy Infrastructure Suite | Factory services

FACTORY BASED SERVICES

		ProDeployFactory Configuration	ProDeploy Rack Integration
Asset configuration	Single point of contact for project management	●	●
	RAID, BIOS and iDRAC configuration	●	●
	Firmware freeze	●	●
	Asset Tagging and Reporting	●	●
	Customer system image	●	●
Factory implementation	Site readiness review and implementation planning	-	●
	Hardware racking and cabling	-	●
	SAM engagement for ProSupport Plus entitled accounts/devices	-	●
	Deployment verification, documentation, and knowledge transfer	●	●
Delivery	White glove logistics	-	●
	Onsite final configuration	-	Onsite add-on
	Install support software and connect with Dell Technologies	-	Onsite add-on
	Basic Deployment	Optional onsite installation	-
Online oversight	Online collaborative environment for planning, managing and tracking delivery	-	●

1 ProDeployRack Integration Services are currently only available within the United States. Custom rack integration services are still available globally.\*

**DELL** Technologies

Figure 35. ProDeploy Infrastructure Suite - Factory services

# ProDeploy Infrastructure Suite | Field services

		Basic Deployment	ProDeploy	ProDeploy Plus
Pre-deployment	Single point of contact for project management	●	●	In-region
	Site readiness review	-	●	●
	Implementation planning <sup>1</sup>	-	●	●
	SAM engagement for ProSupport Plus entitled devices	-	-	●
Deployment	Deployment service hours	Business hours	24x7	24x7
	Onsite hardware installation and packaging material removal <sup>2</sup> or remote guidance for hardware installation <sup>1</sup>	●	Remote guidance or onsite	Onsite
	Install and configure system software	-	Remote	Onsite
	Install support software and connect with Dell Technologies	-	●	●
	Project documentation with knowledge transfer	-	●	●
Post-deployment	Deployment verification	-	●	●
	Configuration data transfer to Dell Technologies technical support	-	●	●
	30-days of post-deployment configuration assistance	-	-	●
	Training credits for Dell Technologies Education Services	-	-	●
Online oversight	Online collaborative environment in <a href="#">TechDirect</a> for planning, managing and tracking delivery <sup>3</sup>	-	●	●

<sup>1</sup> Remote option includes project specific instructions, documentation and live expert guidance for hardware installation. Option available for select hardware. [List is available in the backup portion of this customer presentation](#)

<sup>2</sup> Packaging removal included with onsite hardware installation

<sup>3</sup> Included with ProDeploy or ProDeploy Plus, Not included with Basic Deployment

Figure 36. ProDeploy Infrastructure Suite - Field services

## Dell ProDeploy Plus for Infrastructure

From beginning to end, ProDeploy Plus provides the skill and scale that is must successfully perform demanding deployments in today's complex IT environments. Certified Dell experts start with extensive environmental assessments and detailed migration

planning and recommendations. Software installation includes set up of our enterprise connectivity solution (secure connect gateway) and OpenManage system management utilities.

Postdeployment configuration assistance, testing, and product orientation services are also available.

## Dell ProDeploy for Infrastructure

ProDeploy provides full-service installation and configuration of both server hardware and system software by certified deployment engineers including set up of leading operating systems and hypervisors as well our enterprise connectivity solution (secure connect gateway) and OpenManage system management utilities. To prepare for the deployment, we conduct a site readiness review and implementation planning exercise. System testing, validation, and full project documentation with knowledge transfer complete the process.

## Dell Basic Deployment

Basic Deployment delivers worry-free professional installation by experienced technicians who know Dell servers inside and out.

## Additional Deployment Services

You can tailor the ProDeploy Infrastructure Suite offer to meet your customer's unique needs by leveraging "Additional Deployment Time." ADT will cover additional tasks above the normal scope of the standard offers. ADT can be sold for Project Management or Technical Resources and is sold as blocks of four hours remote or eight hours on-site.

## Dell ProDeploy for HPC (available in US/Canada only. All other regions use custom)

HPC deployments require specialists that understand that cutting edge is yesterday's news. Dell deploys the world 's fastest systems and understands the nuances that make them perform. ProDeploy for HPC provides:

- Global team of dedicated HPC specialists
- Proven track record, thousands of successful HPC deployments
- Design validation, benchmarking, and product orientation

Learn more at [Dell.com/HPC-Services](https://Dell.com/HPC-Services).

# ProDeploy Expansion for HPC

\*Available as standard SKUs in US & Canada and as custom quote in APJC, EMEA, LATAM

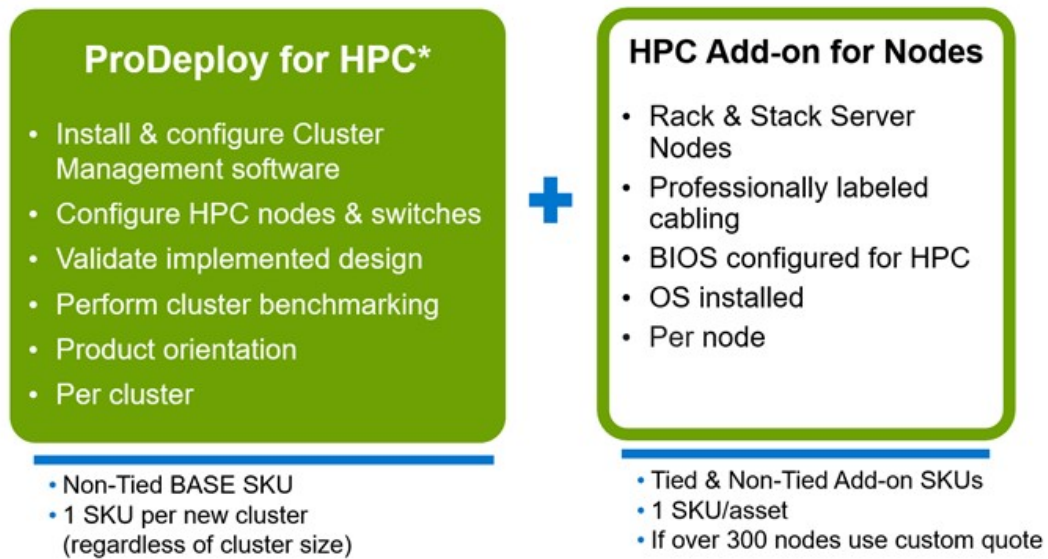


Figure 37. ProDeploy Expansion for HPC

## Dell custom deployment Services

Dell custom rack integration and other Dell configuration services help customers save time by providing systems that are racked, cabled, tested, and ready to be integrated into the data center. Dell support preconfigure RAID, BIOS and iDRAC settings, install system images, and even install third-party hardware and software.

For more information, see [Server Configuration Services](#).

## Dell Residency Services

Residency Services help customers transition to new capabilities quickly with the assistance of onsite or remote Dell experts whose priorities and time they control.

Residency experts can provide post implementation management and knowledge transfer that is related to a new technology acquisition or day-to-day operational management of the IT infrastructure.

## Dell Data Migration Services

Protect business and data of the customer with our single point of contact to manage data migration projects.

A customer project manager works with our experienced team of experts to create a plan using industry-leading tools and proven processes that are based on global best practices to migrate existing files and data, so business systems are up and running quickly and smoothly.

# Dell Enterprise Support Services

## Dell ProSupport Enterprise Suite

With the ProSupport Enterprise Suite, we help keep IT systems running smoothly, so customers can focus on running their business. We help maintain peak performance and availability of the most essential workloads. ProSupport Enterprise Suite is a suite of support services that enable customers to build the solution that is right for their organization. They choose support models that are based on how they use technology and where they want to allocate resources. From the desktop to the data center, address everyday IT challenges, such as unplanned downtime, mission-critical needs, data and asset protection, support planning, resource allocation, software application management and more. Optimize customer IT resources by choosing the right support model.

**Table 71. ProSupport Enterprise Suite**

Service	Support model	Description
ProSupport Enterprise Suite	ProSupport Plus for Enterprise	Proactive, predictive, and reactive support for systems that look after your business-critical applications and workloads
	ProSupport for Enterprise	Comprehensive 24 x 7 predictive and reactive support for hardware and software
	Basic hardware support	Reactive hardware support during normal business hours

## Dell ProSupport Plus for Enterprise

When customers purchase PowerEdge server, we recommend ProSupport Plus, our proactive and preventative support service for business-critical systems. ProSupport Plus provides all the benefits of ProSupport, plus the following:

- An assigned Services Account Manager who knows their business and environment
- Immediate advanced troubleshooting from an engineer
- Personalized, preventive recommendations that are based on analysis of support trends and best practices from across the Dell Technologies infrastructure solutions customer base to reduce support issues and improve performance
- Predictive analysis for issue prevention and optimization that is enabled by secure connect gateway technology
- Proactive monitoring, issue detection, notification, and automated case creation for accelerated issue resolution enabled by secure connect gateway
- On-demand reporting and analytics-based recommendations that are enabled by secure connect gateway and TechDirect

## Dell ProSupport for Enterprise

ProSupport service offers highly trained experts around the clock and around the globe to address IT needs. We help minimize disruptions and maximize availability of PowerEdge server workloads with:

- 24x7 support through phone, chat and online
- Predictive, automated tools and innovative technology
- A central point of accountability for all hardware and software issues
- Collaborative third-party support
- Hypervisor, operating system and application support
- Consistent experience regardless of where customers are located or what language they speak

**NOTE:** Subject to service offer country or region availability.

- Optional onsite parts and labor response options including next business day or four-hour mission critical

ProSupport Enterprise Suite Feature Comparison			
	Basic	ProSupport	ProSupport Plus
Remote technical support	9x5	24x7	24x7
Covered products	Hardware	Hardware Software	Hardware Software
Onsite hardware support	Next business day	Next business day or 4hr mission critical	Next business day or 4 hr mission critical
3 <sup>rd</sup> party collaborative assistance		●	●
Self-service case initiation and management		●	●
Access to software updates		●	●
Proactive storage health monitoring, predictive analytics and anomaly detection with CloudIQ and the CloudIQ mobile app		●	●
Priority access to specialized support experts			●
Predictive detection of hardware failures			●
3 <sup>rd</sup> party software support			●
An assigned Service Account Manager			●
Proactive, personalized assessments and recommendations			●
Proactive systems maintenance			●

Availability and terms of Dell Technologies Services vary by region and by product. For more information, please view our [service descriptions](#).

Internal Use - Confidential 23 of 117 © Copyright 2022 Dell Inc. **DELL** Technologies

Figure 38. ProSupport Enterprise Suite

## Dell ProSupport One for Data Center

ProSupport One for Data Center offers flexible site-wide support for large and distributed data centers with more than 1,000 assets. This offering is built on standard ProSupport components that leverage our global scale but are tailored to a customer's needs. While not for everyone, this service option offers a truly unique solution for Dell Technologies largest customers with the most complex environments.

- Team of assigned Services Account Managers with remote, on-site options
- Assigned ProSupport One technical and field engineers who are trained on the customer's environment and configurations
- On-demand reporting and analytics-based recommendations that are enabled by secure connect gateway and TechDirect
- Flexible on-site support and parts options that fit their operational model
- A tailored support plan and training for their operations staff

## Dell ProSupport Add-on for HPC

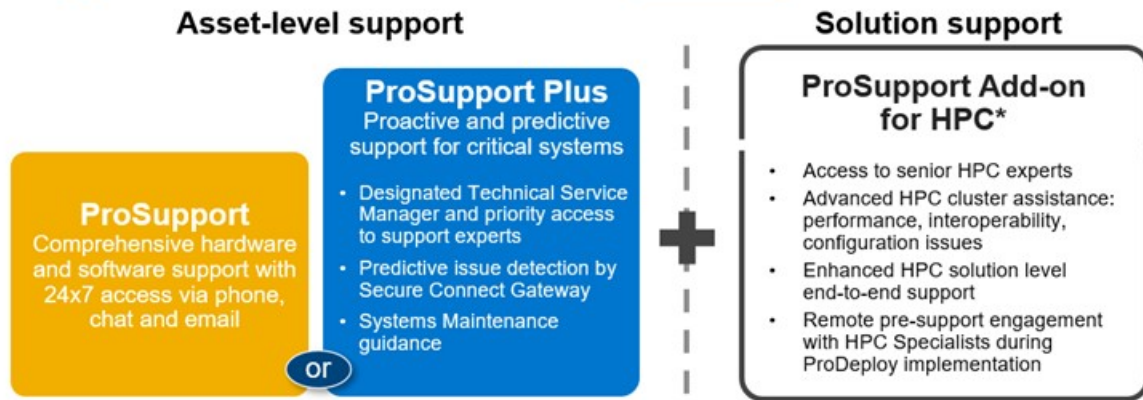
The ProSupport Add-on for HPC provides solution-aware support including:

- Access to senior HPC experts
- Advanced HPC cluster assistance: performance, interoperability, and configuration
- Enhanced HPC solution level end-to-end support
- Remote presupport engagement with HPC Specialists during ProDeploy implementation

Learn more at [Dell.com/HPC-Services](https://Dell.com/HPC-Services).



# ProSupport Add-on for HPC is an add-on to PS or PSP



### Eligibility

- All server, storage, and networking nodes in cluster must have PS or PSP **AND** PS Add-on for HPC attached
- All HW expansions to clusters must attach PS or PSP **AND** PS Add-on for HPC
- To retrofit an entire existing cluster with PS Add-on for HPC:
  1. HPC Specialists must review and validate the existing cluster
  2. PS or PSP **AND** the PS Add-on for HPC (APOS) must be attached to all server, storage and networking nodes

\*Available in standard SKUs in NA and EMEA and as custom quote in APJC & LATAM

DELLTechnologies

Figure 39. ProSupport Add-on for HPC is an add-on to PS or PSP

## Support Technologies

Powering the support experience with predictive, data-driven technologies.

**NOTE:** SupportAssist Enterprise capabilities are now part of the secure connect gateway technology.

## Enterprise connectivity

The best time to solve a problem is before it happens. The automated proactive and predictive support features enabled by the secure connect gateway technology helps reduce steps and time to resolution, often detecting issues before they become a crisis. The gateway technology is available in virtual and application editions. It is also implemented as a direct connect version for select Dell hardware and a Services plugin within OpenManage Enterprise for PowerEdge servers. The legacy SupportAssist Enterprise solution has been retired and is now replaced by the secure connect gateway solutions.

Benefits include:

- Value: Our connectivity solutions are available to all customers at no additional charge
- Improve productivity: Replace manual, high-effort routines with automated support
- Accelerate time to resolution: Receive issue alerts, automatic case creation, and proactive contact from Dell experts
- Gain insight and control: Optimize enterprise devices with insights in portals reporting like TechDirect, and get predictive issue detection before the problem starts

**NOTE:** Connect devices can access these features. Features vary depending on the service level agreement for the connected device. ProSupport Plus customers experience the full set of automated support capabilities.

Table 72. Features enabled by connectivity

	Basic hardware warranty	ProSupport	ProSupport Plus
Automated issue detection and system state information collection	Supported	Supported	Supported
Proactive, automated case creation and notification	Not supported	Supported	Supported

**Table 72. Features enabled by connectivity (continued)**

—	<b>Basic hardware warranty</b>	<b>ProSupport</b>	<b>ProSupport Plus</b>
Predictive issue detection for failure prevention	Not supported	Not supported	Supported

Get started at [DellTechnologies.com/secureconnectgateway](https://DellTechnologies.com/secureconnectgateway).

## Dell TechDirect

TechDirect helps boost IT team productivity when supporting Dell systems.

Boost your productivity with online service for Dell products from TechDirect. From deployment to technical support, TechDirect lets you do more with less effort and faster resolution. You can:

- Open and manage support requests or in-warranty systems
- Execute online self-service for parts dispatch
- Collaborate on ProDeploy infrastructure deployment projects online
- Manage proactive and predictive alerts from secure connect gateway technology that help maximize uptime
- Integrate services functionality into your help desk with TechDirect APIs
- Join over 10,000 companies that choose TechDirect

Register at [TechDirect.Dell.com](https://TechDirect.Dell.com).

## Dell Technologies Consulting Services

Our expert consultants help customers transform faster, and quickly achieve business outcomes for the high value workloads Dell PowerEdge systems can handle. From strategy to full-scale implementation, Dell Technologies Consulting can help determine how to perform IT, workforce, or application transformation. We use prescriptive approaches and proven methodologies that are combined with portfolio and partner ecosystem of Dell Technologies to help achieve real business outcomes. From multi cloud, applications, DevOps, and infrastructure transformations, to business resiliency, data center modernization, analytics, workforce collaboration, and user experiences-we are here to help.

## Dell Managed Services

Some customers prefer Dell to manage the complexity and risk of daily IT operations, Dell Managed Services utilizes proactive, AI enabled delivery operations and modern automation to help customers realize desired business outcomes from their infrastructure investments. With these technologies, our experts run, update and fine-tune customer environments aligned with service levels, while providing environment-wide and down-to-the-device visibility. There are two types of managed service offers. First the outsourcing model or CAPEX model where Dell manages the customer owned assets using our people and tools. The second is the as-a-Service model or OPEX model called APEX. In this service, Dell owns all technology and all the management of it. Many customers will have a blend of the two management types depending on the goals of the organization.

<b>Managed</b>	Outsourcing or CAPEX model	<b>APEX</b>	as-a-Service or OPEX model
<p>We manage your technology using our people and tools.<sup>1</sup></p> <ul style="list-style-type: none"> <li>• Managed detection and response*</li> <li>• Technology Infrastructure</li> <li>• End-user (PC/desktop)</li> <li>• Service desk operations</li> <li>• Cloud Managed (Pub/Private)</li> <li>• Office365 or Microsoft Endpoint</li> </ul>		<p>We own all technology so you can off-load all IT decisions.</p> <ul style="list-style-type: none"> <li>• APEX Cloud Services</li> <li>• APEX Flex on Demand elastic capacity</li> <li>• APEX Data Center Utility pay-per-use model</li> </ul>	

1 – Some minimum device counts may apply. Order via: [ClientManagedServices.sales@dell.com](mailto:ClientManagedServices.sales@dell.com)

\* Managed detection and response covers the security monitoring of laptops, servers, & virtual servers. Min. 50 devices combined. No Networking or Storage-only systems [SAN/NAS]. Available in 32 countries. [Details here](#)

**Figure 40. Dell Managed Services**

## Dell Technologies Education Services

Build the IT skills required to influence the transformational outcomes of the business. Enable talent and empower teams with the right skills to lead and perform transformational strategy that drives competitive advantage. Leverage the training and certification required for real transformation.

Dell Technologies Education Services offers PowerEdge server training and certifications that are designed to help customers achieve more from their hardware investment. The curriculum delivers the information and the practical, firsthand skills that their team must confidently install, configure, manage, and troubleshoot Dell servers.

To learn more or register for a class today, see [Education.Dell.com](http://Education.Dell.com).